

CAROL NEWS

VOLUME 3

ISSUE 25

BOX 1813

LABRADOR CITY

APRIL 11th, 1968

AUTHORIZED AS SECOND CLASS MAIL BY THE POST OFFICE DEPARTMENT OTTAWA, AND FOR
PAYMENT OF POSTAGE IN CASH

- EDITORIAL -

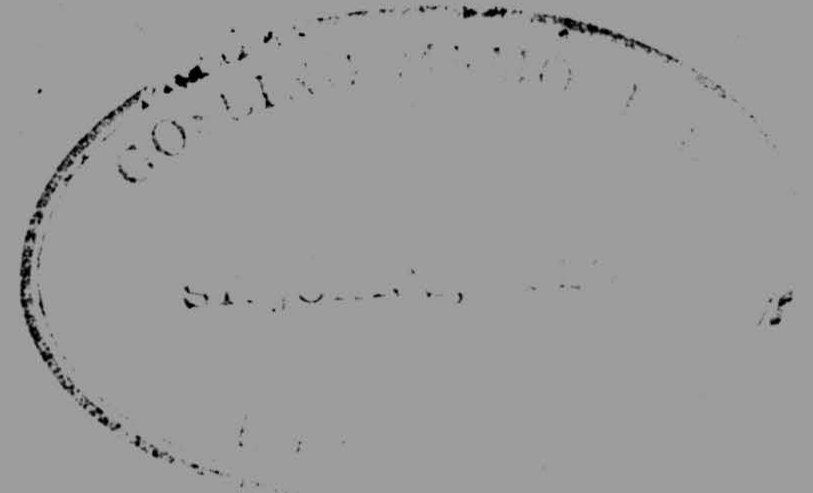

PEOPLE THE WORLD OVER WERE SHOCKED AND ANGERED WHEN THE NEWS REACHED THEM LAST WEEK OF THE BRUTAL MURDER OF DR. MARTIN LUTHER KING.

ESSENTIALLY A MAN OF PEACE, HE MET A VIOLENT DEATH IN MEMPHIS, TENNESSEE AT DUSK ON THURSDAY LAST.

ALL HIS LIFE, DR KING, SON OF A BAPTIST MINISTER HAD WORKED ONLY FOR THE GOOD OF HUMANITY, PREACHING LOVE AND BROTHERHOOD BETWEEN THE BLACK AND WHITE RACES. HE DIDN'T JUST SIT BACK WITH HIS ARMS FOLDED WISHING THE WORLD WAS A BETTER PLACE TO LIVE IN, LIKE SO MANY OF US ARE APT TO DO. INSTEAD HE 'GOT IN THERE' AND WITH INCREDIBLE ENERGY, WORKED WITHOUT REST TO MAKE HIS DREAM BECOME A REALITY. DAYS AND SOMETIMES WEEKS WERE SPENT IN JAIL CELLS AWAY FROM HIS WIFE AND FAMILY AND ABUSE AND THREATS CAME FROM EVERY SIDE, BUT STILL HE CONTINUED IN HIS WAR AGAINST HATRED AND RACISM.

HUMBLY, WE PAY TRIBUTE TO DR. MARTIN LUTHER KING, WHOSE DREAM OF BROTHERHOOD WE HOPE WILL ONE DAY BE REALIZED.

INSIDE YOUR CAROL NEWS

CHURCH CALENDAR
DON'S SPORTS BEAT
T.V. SCHEDULE

ADVERTISING
X-WORD

COMING EVENTS
CHIT-CHAT
PERSONAL ADS.

- CHURCH CALENDAR FOR EASTER -

PENTECOSTAL CHURCH - GLAD TIDINGS
TABERNACLE - Pastor B.H.Hartwell:
 NO SERVICE THIS THURSDAY.

GOOD FRIDAY NIGHT SERVICE AT 8:00 pm.

EASTER SUNDAY APRIL 14th:

7:00 am Sunrise Prayer Service
 11:00 am Morning Worship
 3:00 pm Open Sunday School
 7:30 pm Evangelistic Service

MIDWEEK GROUPS:

Prayer Service on Tuesday at 8:00 pm
 Women's Missionary Council on Monday
 at 8:00 pm.

SALVATION ARMY CITADEL

Captain Carew:

HOME LEAGUE MEETING 8:15 pm THURSDAY

GOOD FRIDAY:

11:00 am United Service at Carol United
 (speaker: Bapt. J. Carew.) Church.
 8:00 pm United Service at Salvation
 Army Citadel.

EASTER SUNDAY:

6:00 am Sunrise Service
 11:00 am Holiness Meeting
 2:30 pm Sunday School
 7:30 pm Evangelistic Meeting.

OUR LADY OF PERPETUAL HELP

FATHER O. DESMARAIS - FATHER F. LEMIRE:

HOLY THURSDAY APRIL 11th:

Mass and Communion 4:00 pm:
 (First Communion-Grade 2 French)

Service at 8:00 pm followed by Confessions Office 3:00 pm.

GOOD FRIDAY:

Confessions from 2:00 - 3:00 pm:
 Service & Holy Communion 3:00 pm:
 STATIONS OF THE CROSS 7:30 pm:

HOLY SATURDAY:

Confessions 4:00-5:00 pm: 7:00-8:00 pm:
 and 9:00 - 10:00 pm:

Vigil Pascal 11:00 pm: followed by
 MIDNIGHT MASS.

EASTER SUNDAY:

Mass 9:00 am 11:00 am 5:00 pm (french)
 and 7:00 pm:

CONFESSIONS every night from Wednesday
 to Saturday. None during religious
 services.

ST. PETER'S ANGLICAN CHURCH-WABUSH.

Rev. L. Whitten:

THURSDAY APRIL 11th.

Holy Communion 7:30 pm.

GOOD FRIDAY:

Holy Communion 8:30 am.

THREE HOURS DEVOTION FROM 12:00 noon to
 3:00 pm.

EASTER SUNDAY:

Sunday School 11:00 am.
 Evening Prayer 7:00 pm.

CAROL UNITED CHURCH

Rev. Eric Snider:

GOOD FRIDAY: JOINT SERVICE AT THE
 SALVATION ARMY CITADEL - 8:00 pm: Speaker

EASTER SUNDAY: Rev. Eric Snider.

Holy Communion 8:30 am

Sunday School for Junior 9-11

Intermediates 12 - 15 yrs. 9:30 am

Morning Worship 11:00 am

(Nursery & Kindergarten

5 yrs and under, Cradle roll

2 yrs and under.)

PRIMARY EASTER PROGRAMME 2:30 pm

Holy Communion 6:30 pm

EASTER PAGEANT AND EVENING
 SERVICE 7:15 pm.

MIDWEEK GROUPS: SPECIAL PROGRAMMES
 HAVE BEEN ARRANGED BY EACH GROUP.

OUR LADY OF THE ASSUMPTION - WABUSH

Rev. J. Bergeron:

HOLY THURSDAY APRIL 11th:

Mass 4:00 pm 7:00 pm.

GOOD FRIDAY:

Office 3:00 pm.

HOLY SATURDAY:

Vigil Pascal 11:30 pm. followed by
 MIDNIGHT MASS.

EASTER SUNDAY:

Mass 10:00 am 7:00 pm.

ST. PAUL'S ANGLICAN CHURCH

Rev. L. Whitten:

THURSDAY APRIL 11th:

Junior Choir Practice at 6:30 pm.

Holy Communion 5:15 pm.

B.A.C. Meeting 8:00 pm.

GOOD FRIDAY:

Morning Prayer 10:00 am.

JOINT SERVICE AT THE

SALVATION ARMY CITADEL 8:00 pm.

EASTER DAY:

Holy Communion 6:30 am.

Sunday School 9:45 am.

Holy Communion 11:00 am.

Evening Prayer 7:00 pm.

CHRIST CHURCH - WABUSH (SERVICES UPSTAIRS
 IN REC. CENTRE)

Rev. Blake Walker:

GOOD FRIDAY SERVICES:

Morning Service 10:00 am.

Evening Service in the

Salvation Army Citadel

Labrador City. 8:00 pm.

EASTER SUNDAY:

Sunday School 9:45 am

Morning Worship 11:00 am

Easter Hymn Sing and

Fellowship Hour. 7:00 pm

(Soloist and special music)

MIDWEEK MEETING EVERY WEDNESDAY AT

8:00 pm: 30, Bond Avenue.

GOOD FRIDAY:

UNION SERVICES WILL BE HELD AT

CAROL UNITED CHURCH AT 11:00 am

AND THE SALVATION ARMY CITADEL

AT 8:00 pm: PARTICIPATING CLERGY

WILL BE REV. ERIC SNIDER

REV. L. WHITTEN

PASTOR HARTWELL

CAPTAIN J. CAREW

A very pretty wedding took place on March 22nd in Our Lady Of Perpetual Help Church of Miss Shirley McGrath and Mr. Joseph Schnezler, both of Labrador City. The ceremony with Nuptual Mass was officiated over by Rev. Father Desmarais and the organist was Miss Jo Decey. Miss McGrath was given away by Mr. Edgar Blundon and was attended by two bridesmaids, Miss Joan Delaney R.N. and Miss Delia Martin R.N. The groom was attended by Mr. James Dillon and Mr. Alan Wells.

Out of town guests were the bride's mother, Mrs. Margaret McGrath from Newfoundland and the groom's parents Mr & Mrs. Ernest Schnezler and three sisters from Montreal.

Mr & Mrs Ray Jessop of 322, Elizabeth Avenue, Labrador City are pleased to announce the engagement of their elder daughter, LARAINÉ ANN to MR KENNETH ROWE, son of Mr & Mrs. Albert Rowe of St. John's, Newfoundland.

The Baptisms took place on SUNDAY April 7th at St. Paul's Anglican Church of
SUSAN LYNN CANNING, daughter of Mr & Mrs Harris Canning
JOCELYN RAY, daughter of Mr & Mrs Leon Ray
SEAN CHARLES STEVENS, son of Mr & Mrs. Charles Stevens
All of Labrador City.

Our very best wishes go with Grace and Cyril Vincent who are leaving soon to return home to Newfoundland. Cyril has been working for the past six months with Northern Drugs in Wabush and indeed it doesn't seem two minutes since we were welcoming them to our community.

The Baptism took place in the Church of Our Lady of Perpetual Help on Sunday last, April 7th. of NATHALIE SONIA SKRYZPCZAK, daughter of Mr & Mrs Eddie Skryzpczak of Labrador City. The baby's Godparents are Marie and Claude Corbeil.

- MEMORIAL UNIVERSITY ALUMNI ASSOCIATION, LABRADOR CITY/WABUSH BRANCH -

A lecture given by Dr. Leslie Harris, Dean of Arts and Science, Memorial University of Newfoundland, will be held in the gymnasium of the Labrador City Collegiate at 8:00 pm: on April 25th, 1968.

The topic of the lecture will be - NEWFOUNDLAND HISTORY 1861 - YEAR OF STRIFE AND ACCOMODATION.

The general public is invited and there will be no charge for admission. Following the lecture an informal reception will be held in the All-purpose room.

MR. L. AUBÉ, A PIANO TUNER, WILL BE IN THE LABRADOR CITY / WABUSH AREA DURING THE WEEK OF APRIL 15th: ANY PERSON REQUIRING HIS SERVICES IS ASKED TO CONTACT MR. DAVID SELLECK AT 944-2900.

NOTE OF THANKS

The Kinsmen Club of Wabush Area would like to express their appreciation to all those who were involved in and participated in the search-and-rescue of one of their Kinsmen on Sunday afternoon, March 24. Personal thanks come from the survivor himself, who was engaged in the running off of the Ski-Doo and Snowshoe Races during our Winter Carnival Project.

ROYAL CANADIAN SEA CADETS

Recently returned to Wabush is Leading Cadet, Deryck Collins who is acting Chief Petty Officer of R.C.S.C.C. "Labrador" the Sea Cadet Corp sponsored by Branch 47 of the Royal Canadian Legion in Labrador City.

Leading Cadet Collins looking bronzed and fit has just spent 10 weeks serving with the Royal Canadian Navy, aboard H.M.C.S. "St. Laurent" one of the latest destroyer escorts. The "St. Laurent" together with other units of the East Coast Fleet were taking part in exercise "Maple Spring '68" in Southern waters. During this time Collins visited San Juan, Puerto Rico, the Virgin Islands and New Orleans.

During his time on board he carried out part ship work, standing regular watch and station duties as an active member of the crew. He brought back a very good Divisional Assessment from his Divisional Officer.

Cadet Collins states that it was a wonderful experience and seems completely "sold" on the Navy. He advised all his fellow cadets to work hard and try to avail themselves of the same opportunity.

The R.C.N. as part of Cadet training regularly allots berths to selected cadets on their cruises. To be eligible cadets must have served 2 years with the Corp, be rated Leading Cadet or above, be 17 years old and must have at least one two week training period at Summer Camp.

This year, 6 cadets will be attending C.F.D. "Cornwallis" N.S. for 2 weeks summer camp and it is hoped that at least one senior cadet will be attending the 6 weeks Bosun's course. Cadet Collins is being recommended for the 6 week course on Practical Leadership.

THE CANADIAN RED CROSS SOCIETY OVER ONE AND A HALF MILLION ACTIVE YOUTH

There are, in Canada, today over one and a half million boys and girls, who are actively engaged in the humanitarian programmes of the Canadian Red Cross Society, Mr. Don Evely, Chairman of the Red Cross Youth Advisory Committee disclosed today.

In giving these figures, Mr. Evely said how proud he was to be associated with an organization which was doing such a great deal of work in eliminating suffering and helping the youth of the underdeveloped nations to help themselves and all this in addition to their activities on a local level in providing assistance for the less fortunate than themselves.

The administration costs of this programme are borne by the Red Cross Society. All the funds raised by the Junior members, themselves, are devoted to their work for youth here at home and abroad,

Pennies, nickles and dimes really mount up. Canadian Juniors raise about three hundred thousand dollars annually; with this money, they provide hearing aids, crutches, wheelchairs, dentures, heart surgery, special drugs, transportation to and from medical treatment centres and a variety of other forms of assistance for less fortunate children right here in Canada. Mr. Evely also pointed out that our Juniors are among the first to recognize that while charity begins at home, it does not end there.

They send health kits, school supplies, layettes, toys, technical help, medical assistance and cash grants to about thirty countries each year. It cost them about one hundred thirty thousand dollars. This is big money, but the money itself is only a means of expressing themselves.

Mr. Evely expressed the opinion that this is good citizenship in action and it is through Red Cross Youth that our children learn about this aspect of good citizenship. Mr. Evely said we take our hats off to the many thousand of school teachers, who carry on the Youth Programme in their classrooms.

- IN THE BEGINNING -

Woman was not taken from man's head to be ruled by him - nor from his feet to be trampled upon, but from his side to walk beside him, from under his arm to be protected by him and from near his heart to be loved by him.

PERSONAL ADS:

FOR SALE:

PLEASE RING:

Snare drum (Olympic)

944 - 2983

~~~~~  
Baby carriage, lounge chair, baby scales (pink) ^  
all in excellent condition..... ^

944 - 3334

(would the person advertising these articles,  
please ring 3334 and leave her number)

~~~~~  
Budgie bird, cage and stand \$15 complete

944 - 2028

Heathkit stereo amplifier(30 watts)
Short wave Hallicraft radio, model FX 110
1964 Chevrolet Biscayne, 6 cylinder,standard trans.

944 - 2711

WANTED - GOOD HOMES FOR FOUR KITTENS (6 WEEKS OLD)

944 - 2163

WANTED - A GOOD HOME FOR LABRADOR RETRIEVER (2 YEARS
OLD IN MAY) VERY GOOD WITH CHILDREN

944 - 2028

WANTED - A USED CANOE

944 - 2983

ACCOMODATION REQUIRED

Couple require house, apartment or trailer to rent

944 - 3350

ACCOMODATION AVAILABLE

Room to rent for one gentleman

944 - 2531

Furnished apartment for a couple (403,Bartlett)

944 - 2531

LOST ON SUNDAY MARCH 31st AT TANYA LAKE PARKING LOT
ONE PAIR 'BEARPAW' SNOW SHOES. FINDER RING

944 - 2691

LOST GOLD ST.CHRISTOPHER NECKLACE
(GREAT SENTIMENTAL VALUE) REWARD. PLEASE RING

944 - 2939

- SIMPLE RECIPES TO CUT OUT AND KEEP -
EASTER BISCUITS

INGREDIENTS

4 oz butter
4 oz sugar
2 egg yolks
1 tsp. brandy
2 oz.currants
10 oz.flour
Egg white
Caster sugar

METHOD

Cream fat and sugar and beat in egg yolks. Add brandy
and fruit. Work in flour, with a very little milk if
needed to bind into a paste softer than pastry dough,
but possible to roll out. Prick, and cut into rounds
with a fluted cutter. Bake on a greased tin in a
moderately hot oven (400° F:) 15 - 20 minutes. After
10 minutes, brush cakes over with a little egg white
and dredge with caster sugar.

- LOCAL UNION 5795 -

THERE WILL BE AN ELECTION FOR THE OFFICE OF
VICE PRESIDENT

LOCAL UNION 5795 HELD ON SATURDAY APRIL 13th
FROM 9:00 am-6:00 pm
AT THE UNION OFFICE.

- LABRADOR CITY SNO-KART CLUB -

ALL THE CHILDREN OF LABRADOR CITY ARE INVITED OUT
TO TANYA LAKE THIS COMING SUNDAY FROM 1:30 pm to
4:00 pm: THERE WILL BE SNOWMOBILE RIDES AND HOT
CHOCOLATE WILL BE SERVED.

PLEASE NOTE:

PERSONAL ADS. AND SMALL NOTICES ARE PUBLISHED FREE OF CHARGE
DEADLINE FOR MATERIAL - 8:00 pm TUESDAY
SUBSCRIPTIONS \$1:50 PER YEAR.

PLEASE REMEMBER WE ARE ALWAYS GRATEFUL FOR ANY NEWS ITEMS YOU
MAY HAVE, OR CHIT-CHAT YOU THINK MAY BE OF INTEREST TO OUR READERS.

- MINOR HOCKEY SCHEDULE -

APRIL 11th Thursday (If necessary)
Wabush Juveniles vs Carol Cleaners 5:45 pm.
APRIL 11th Thursday Pee Wee All Star Practice 4:45 pm.
APRIL 13th Saturday 1st game of Juvenile Finals 11:00 am.
Northern Sports vs Winner of Carol Cleaners, Wabush.
APRIL 15th Monday 2nd game 4:45 pm.
Northern Sports vs Winner of Carol Cleaners, Wabush.
APRIL 16th Tuesday 3rd game (if necessary) 4:45 pm.

A LETTER TO THE EDITOR

The Editor,
Carol News

St. John's, Nfld.
March 29th, 1968.

Dear Madam,

It is our earnest intention to reply to the rather slanderous remarks directed at the Newfoundland Labrador Amateur Basketball Association in the March 21st, 1968 issue of your paper and we hope that it is your policy to publish letters to the editor.

These cutting remarks of Mr. Winsor demand a reply from us. It seems to me that he, as a sporting gentleman, should have ascertained the facts before publicizing such an inference.

HERE ARE THE PRECISE FACTS:

The tournament was to open with all six teams in action Friday night. However, two teams (Baie Verte and Labrador City) requested that they not be scheduled until Saturday. This limited the draw and placed both teams into the first game on Saturday. If they had played Friday night, the maximum number of Saturday games would have been three.

With reference to Sunday play, the Torbay Recreation Centre is unavailable for competitive sport (Government policy). It was only through the action of the Minister of Provincial Affairs, Dr. Frecker, that we obtained the facilities for the championship game (s) on Sunday afternoon and such games had to be completed between the hours of one and five.

Thank you for informing us that Monday was a holiday. I am sure that all teachers, university students, and Bowater employees would be very happy to know that they had a holiday but still went about their business as usual.

Does Mr. Winsor think that the executive of the N.L.A.B.A. are living in oblivion? Does he think that all possibilities went uninvestigated? A perfect double elimination tournament had been planned by the N.L.A.B.A. for the weekend until an unfortunate change was requested and granted which necessitated Saturday's situation.

As for the ball control actions of Memorial University's basketball team, they were within Canadian Amateur Basketball rules, but certainly not within the spirit, as the tournament intended. However, these actions in no way condone the flagrant foul committed by a Labrador City player.

Incidentally, no one in sports pays much serious attention to comments of an individual who cannot spell FEILDLANS correctly.

Yours in sport,

ALBERT D. HAYNES

President Nfld. & Labrador
Amateur Basketball Association.

FRANK T. BUTLER,

Secretary-Treasurer Nfld &
Labrador Amateur Basketball Assoc:

(We reserve the right to edit any letters published in this column)

PROTECTION OF EVERY DESCRIPTION
FIRE AUTO SKIDOO MARINE LIFE DISABILITY

RAY HAMMOND

Representative for

TOMLINSONS INSURANCE

MAKE YOUR RESERVATION NOW !!
FOR YOUR FAMILIES' EASTER
NIGHT DINNER

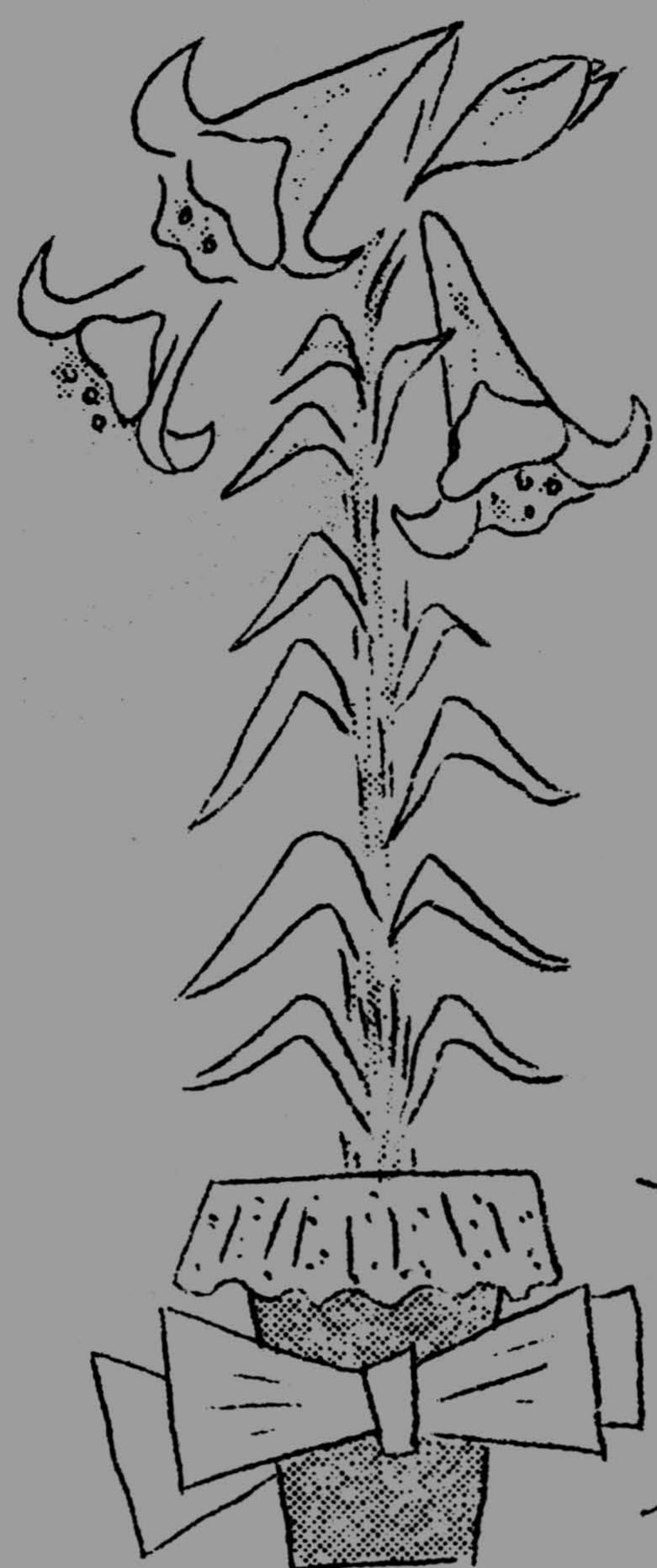

AT
THE SIR
WILFRED
GRENFELL
HOTEL

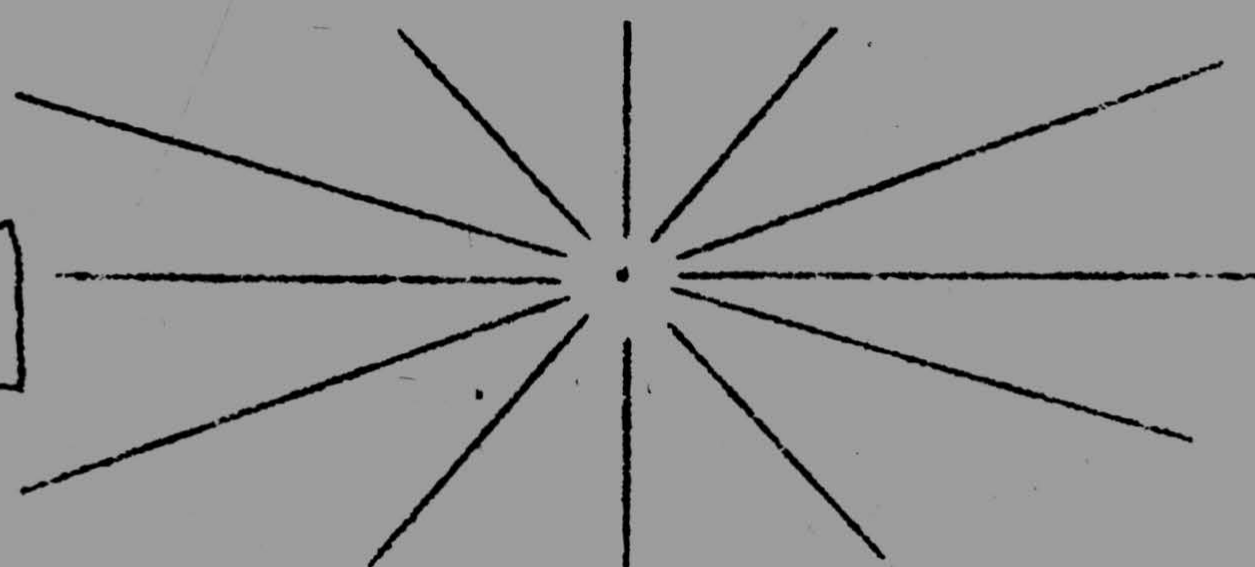
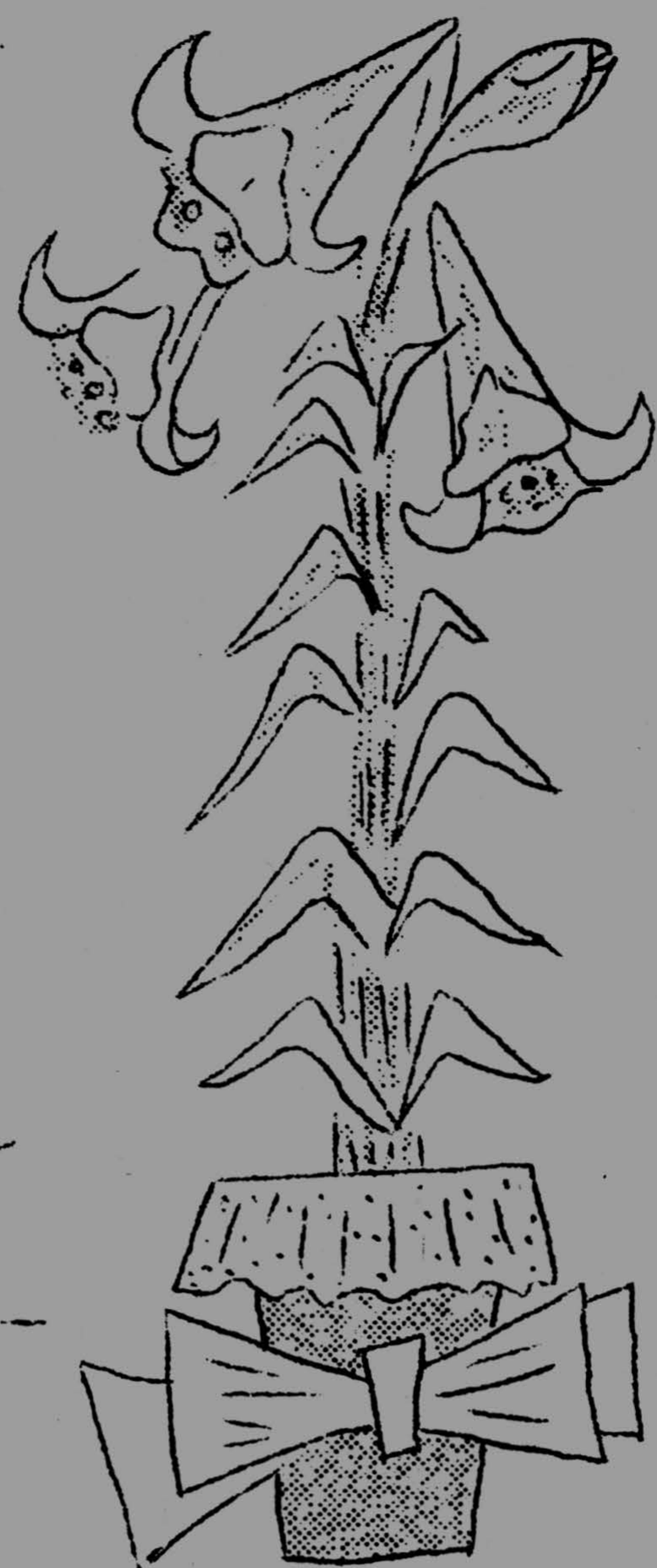

DINING ROOM OPEN FROM 6-9PM

MUSIC BY

===== TOMMY BURNSIDE =====

FOR RESERVATIONS CALL 282-3221

CHILDRENS DINNER 1/2 PRICE

COMING ATTRACTION

APRIL 19TH 20TH 21ST

TV'S
"COUSIN"
"CLEM"

THE GORDIE TAPP
SHOW

DON'T FORGET - WE HAVE DANCING NIGHTLY
IN THE COCKTAIL LOUNGE, TO THE
MUSIC OF TOMMY BURNSIDE

ELECTROLUX

(CANADA) LTD

THE WORLD'S MOST IMITATED
CLEANER AND THE WORLD'S ONLY
FULLY AUTOMATIC CLEANER.....

THE
ZB 88

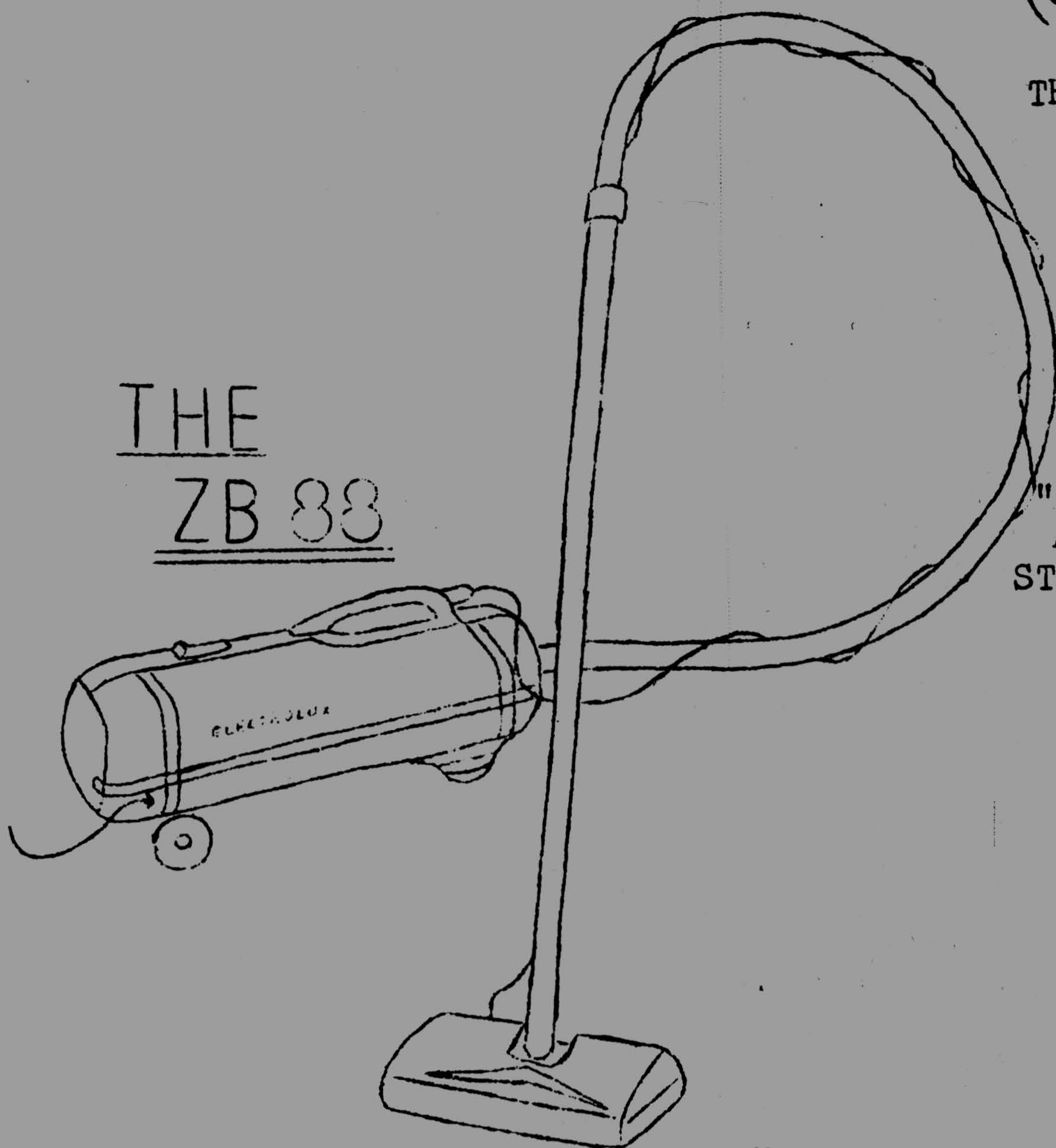

FEATURING THE FAMOUS
Z B. 88 VACUUM
CLEANER WITH THE
" POWER NOZZLE "
AND AN OPTIONAL
STOWAWAY CHEST.

ALSO THE LATEST FLOOR AND RUG
CONDITIONER - THE BX 20 FLOOR
POLISHER, WHICH SCRUBS YOUR
FLOORS, SHAMPOOS YOUR RUGS,
AND POLISHES YOUR FLOOR, ALL
WITH THE SAME MACHINE.

YOU WOULD HAVE TO SEE THIS
WONDERFUL MACHINE TO FULLY
APPRECIATE ITS VALUE.

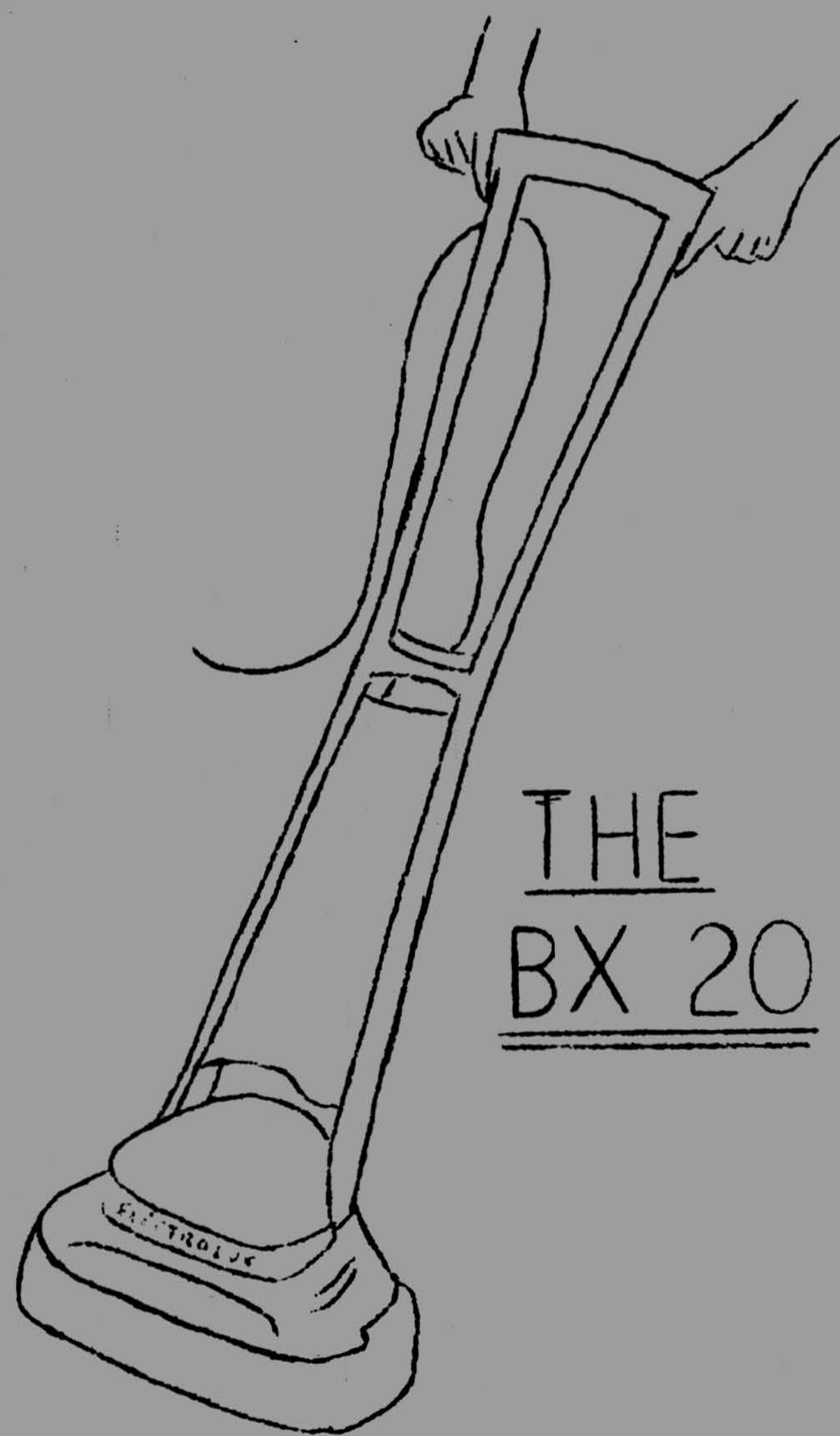

THE
BX 20

YOUR ELECTROLUX REPRESENTATIVE IN LABRADOR
CITY WILL BE PLEASED TO GIVE YOU A FREE
DEMONSTRATION.

WHY NOT GIVE ME A CALL, AND TAKE ADVANTAGE
OF OUR VERY EASY TERMS???

WE HAVE IMMEDIATE DELIVERY, AND STOCK EVERY-
THING FOR YOUR FUTURE NEEDS.

FOR MORE INFORMATION - PLEASE CALL:..... 944 - 2215 or 944 - 2361

A FULL 2-YEAR GUARANTEE ON

ALL OUR PRODUCTS

ELECTROLUX REPRESENTATIVE
FOR LABRADOR CITY & WADUSH

LEN LEYTE



LABRADOR CITY ARENA

WEEKLY SCHEDULE

THURSDAY APRIL 11th	LADIES & TOTS MINOR HOCKEY BROOMBALL AVENGERS vs MILL ROCKETS vs BRAVES	10:00 am 4:45 pm to 6:45 pm 7:30 pm 9:00 pm
FRIDAY APRIL 12th	^^^ ^^^ CLOSED ALL DAY ^^^ ^^^	
SATURDAY APRIL 13th	MINOR HOCKEY PUBLIC SKATING FIGURE SKATING BROOMBALL WAREHOUSE vs WARLOCKS PUBLIC SKATING	8:00 pm to 1:00 pm 2:00 pm to 4:00 pm 4:30 pm to 6:00 pm 7:30 pm 8:30 pm to 10:30 pm
SUNDAY APRIL 14th	CASUAL RENTALS PUBLIC SKATING MINOR HOCKEY BROOMBALL ROYALS vs AVENGERS PUBLIC SKATING	8:00 am to 12:00 am 2:00 pm to 4:00 pm 4:30 pm to 6:30 pm 7:00 pm 8:30 pm to 10:30 pm
MONDAY APRIL 15th	CASUAL RENTALS MINOR HOCKEY BROOMBALL ROCKETS vs ROYALS PUBLIC SKATING	8:00 am to 12:00 noon 4:45 pm to 6:45 pm 7:00 pm 8:30 pm to 10:30 pm
TUESDAY APRIL 16th	LADIES & TOTS MINOR HOCKEY BROOMBALL WARLOCKS vs ROCKETS WABUSH vs WAREHOUSE	10:00 am to 11:30 am 4:45 pm to 6:45 pm 7:30 pm 9:00 pm
WEDNESDAY APRIL 17th	MINOR HOCKEY BROOMBALL WAREHOUSE vs BRAVES PUBLIC SKATING	4:45 pm to 6:45 pm 7:00 pm 8:30 pm to 10:30 pm

REVISED BROOMBALL SCHEDULE - EFFECTIVE APRIL 11th

THURSDAY APRIL 11th:	7:30 pm	AVENGERS vs MILL	9:00 pm	ROCKETS vs BRAVES
SATURDAY APRIL 13th:	7:00 pm	WAREHOUSE vs WARLOCKS		
SUNDAY APRIL 14th:	7:00 pm	ROYALS vs AVENGERS		
MONDAY APRIL 15th:	7:00 pm	ROCKETS vs ROYALS		
TUESDAY APRIL 16th:	7:30 pm	WARLOCKS vs ROCKETS	9:00 pm	WABUSH vs WAREHOUSE
WEDNESDAY APRIL 17th:	7:00 pm	WAREHOUSE vs BRAVES		
THURSDAY APRIL 18th:	7:30 pm	MILL vs ROYALS	9:00 pm	BRAVES vs WARLOCKS
FRIDAY APRIL 19th:	7:30 pm	AVENGERS vs WAREHOUSE	9:00 pm	WABUSH vs ROCKETS
SATURDAY APRIL 20th:	7:00 pm	AVENGERS vs LAB.		
SUNDAY APRIL 21st:	7:00 pm	BRAVES vs ROYALS		
MONDAY APRIL 22nd:	7:00 pm	ROCKETS vs AVENGERS		
TUESDAY APRIL 23rd:	7:30 pm	AVENGERS vs WARLOCKS	9:00 pm	WABUSH vs MILL
WEDNESDAY APRIL 24th:	7:00 pm	LAB. vs WARLOCKS		
THURSDAY APRIL 25th:	7:30 pm	WARLOCKS vs WABUSH	9:00 pm	ROYALS vs WAREHOUSE
FRIDAY APRIL 26th:	7:00 pm	WABUSH vs LAB.		

S P O R T S B E A T

by
"DON"

The curtains were brought down on another hockey season in Labrador City over the past weekend. For our first venture into Provincial and National competition we came out well ahead of expectations and predictions.

The general concensus around the rink after the two games was that we didn't play as well as we should have and the series should have gone the other way. I'll be the first to admit the boys wern't up to par and but for a few mistakes around our own goal, could have won. Just stop for a moment and think back a couple of months, most hockey fans in town wouldn't give a plugged nickel for our chances against the Town Aces, and what happened? The Aces wern't in the same rink! Then when they beat the Cataracts, this was the ultimate! Labrador City are going to have to win a lot of games to equal the pride I felt that night.

Let me say this to the Braves hockey team, "YOU'VE HAD A TREMENDOUS YEAR, YOU WERE GREAT IN VICTORY AND GENTLEMEN IN DEFEAT, YOU HAVE NOTHING TO BE ASHAMED OF AND YOU WERE A CREDIT TO LABRADOR CITY. IF THE REST OF THE RESIDENTS OF OUR TWIN TOWNS RECEIVED HALF THE HOCKEY THRILLS I DID, THEN THEY TOO HAD A WHOLE OF A SEASON. CONGRATULATIONS TO EACH AND EVERY ONE OF YOU !!!

My own personal choices for stars over the year look something like this. Most improved player would have to be Bruce Crowthers for Wabush. M.V.Ps for each team would be Don Higgans, Wabush, Jean Yves Letourneau, Royals and Barry Clouter, Braves. My choice for Most Valuable Player in the local league Jean Yves Letourneau. For All-star and exhibition hockey the most valuable player by far was Leon Coté. Leon proved that if you keep your temper you go a lot further in sport. After Accumulating about 60 minutes in penalties last year plus suspensions, he picked up only two minutes this year and came up with games that were terrific to say the least. The best organized and coached team in the rink this year was the Wabush "B" team. The Most Valuable Player in the "B" league belongs to George Collier from the Wabush team. The most improved player in the "B" league would be Stan Dranton of the Indians.

The most evident thing that was lacking in hockey this year

C O A C H E S !

All divisions of Minor Hockey are entering their play-offs. The boys play every afternoon from 4:45 pm to 6:45 pm: and Saturday mornings from 8:00 am to 1:00 pm: So all you people who haven't seen the kids all season, why not get down to the rink during the next two weeks and cheer the boys on.

Thus far the N.H.L. Playoffs are going as I expected. I pick Montreal to take Boston, New York over Chicago and then the Rangers over the Canadiens. Of course all Jew York has to do will be to show up to win over the new division winner.

Baseball season opens this week and it's pretty early to pick a winner. The only thing for certain is that St.Louis should repeat in the National League. The American League has too many ifs, ands and buts to pick a winner. If Lonborug has a good year, and Tony Conigliaro is well, Boston might repeat, but then Yammy needs another big season. Let's just say we'll all have a better idea in a couple of months.

THAT'S 'THIRTY' FOR THIS WEEK - AND REMEMBER - " IF YOU CAN'T TAKE PART IN SPORT - BE A GOOD ONE ANYWAY "

INSURANCE

FIRE

CONTACT

AUTO

MARINE

BOWRINGS INSURANCE

MISC

(A DIVISION OF BOWRING BROS. LTD)

THE MALL

SHOPPING CENTRE, LABRADOR CITY. MANAGER:MRS.VIRGINIA CAVERLY - PHONE: 944 - 5388

EASTER AT WOOLWORTHS

SOLID CHOCOLATE
EASTER EGGS

99¢ lb

SPECKLED EASTER EGGS

79¢ lb



"NAME" EGGS - NAME
WRITTEN ON FREE

69¢

ASS'T'D HOLLOW
CHOC. NOVELTIES

49¢ — \$3-99



ARTIFICIAL
EASTER
PLANTERS

\$2-99 — 6-99

FILLED EASTER BASKETS

49¢ — \$1-39

FILLED SAND PAILS

49¢ — \$1-29

EASTER COWBOY HATS

\$1-29

WHEEL BARROWS \$2-99

JUST ARRIVED

LIVE EASTER PLANTS

POTTED EASTER LILLIES \$3-99

POTTED "MUMS" \$2-99

POTTED HYDRANGEAS \$6-99

POTTED GERANIUMS \$2-59



"HAPPY EASTER"

FROM

WOOLWORTHS

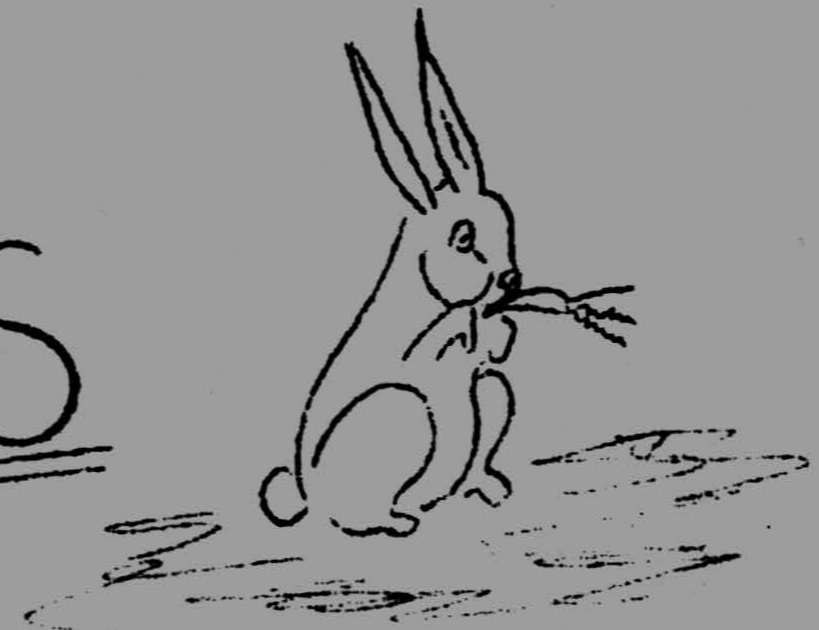

X-WORD PUZZLE

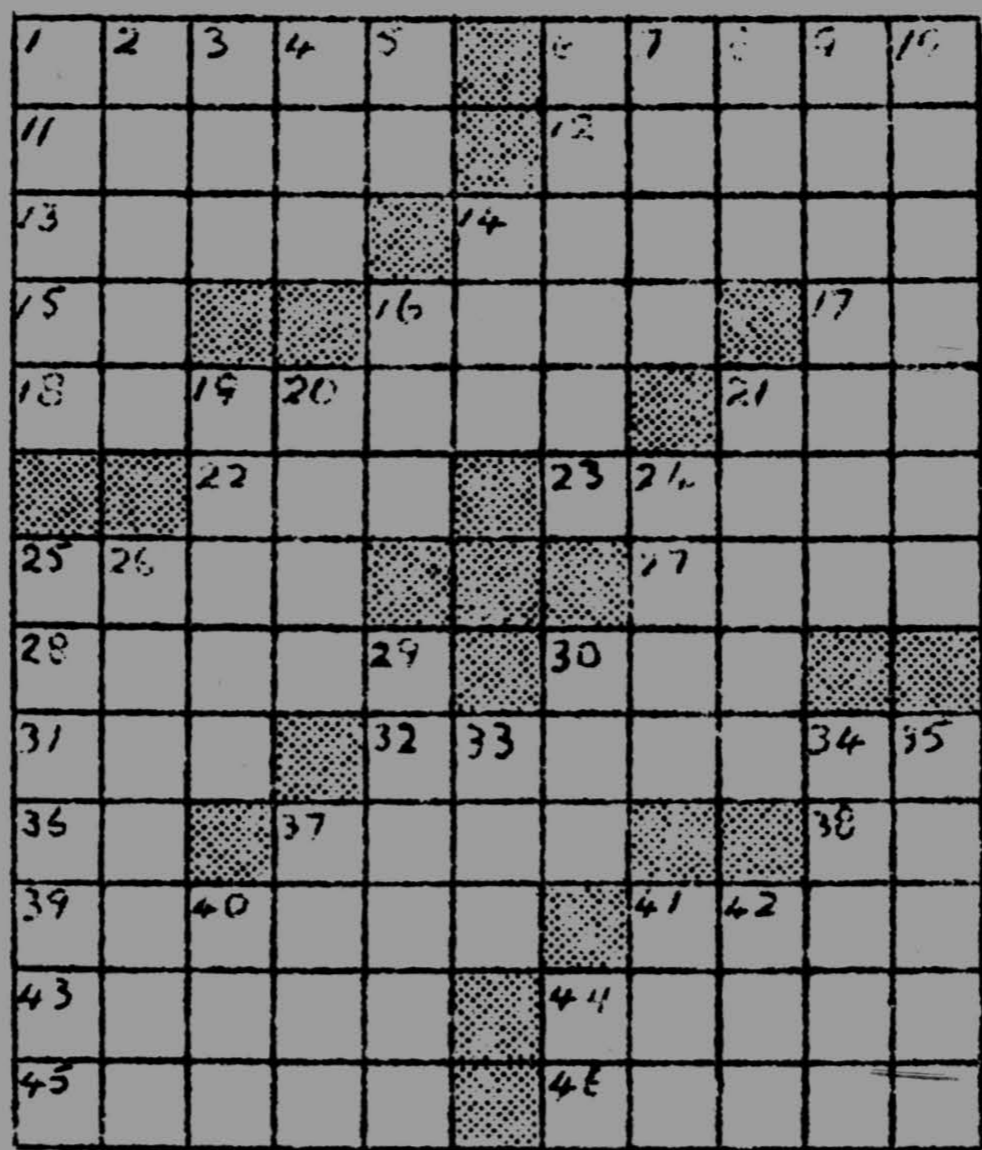

ACROSS

DOWN

- 1. Rock
- 6. Genre
- 11. Citadel
- 12. Intuition
- 13. Furnace
- 14. Cupboard
- 15. Norse god
- 16. Impersonate
- 17. Nickel: sym.
- 18. Printer's error
- 21. Golfer Hogan
- 22. Man's name
- 23. Marabou
- 25. Except
- 27. First film czar
- 28. Volcanic rock
- 30. Dance step
- 31. Lamprey
- 32. Frequented Italian river
- 37. Dispatched
- 38. Music note
- 39. Dishes
- 41. Pack away
- 43. Anxious
- 44. Clamor
- 45. Percolates
- 46. Byway.

- 1. Kitchen range
- 2. Flutter
- 3. Solemn wonder
- 4. Boy's nickname
- 5. Hesitation sound
- 6. Gorges
- 7. Entice
- 8. Moreover
- 9. Stage background
- 10. Contracts
- 14. Gehrig
- 16. Educational group: abbr.
- 19. Competitor
- 20. God of war
- 21. Drag
- 24. Conjunction
- 25. Siberian plains
- 26. Small spaces
- 29. Veers
- 30. Place
- 33. Town near Liege
- 34. Uneven
- 35. Manila Bay hero
- 37. Stair
- 40. Mature
- 41. Phoebus
- 42. Sesame.

THE ANSWERS TO LAST WEEK'S X-WORD

ACROSS

- 1. Agra
- 5. Duad
- 9. Freer
- 10. Urges
- 12. Ionic
- 13. Anise
- 14. Emes
- 15. Sn
- 16. Oks.
- 17. Ar.
- 18. Beef
- 20. Atabal
- 22. Lace
- 26. Rites
- 27. Huron
- 28. Aces
- 29. Vixens
- 30. Ties
- 32. Tn.
- 33. Mac
- 36. Ox
- 37. Chow
- 39. Apart
- 41. Route
- 42. Tibia
- 43. Apses
- 44. Asps
- 45. Yeas

DOWN

- 1. Aromatic
- 2. Generate
- 3. Reis
- 4. Arc
- 5. Duane
- 6. Urn
- 7. Lgio
- 8. Desk
- 9. Fie
- 11. Scs.
- 15. Sel
- 18. Mas
- 19. Flux
- 20. Ara
- 21. Pest
- 23. Arethus
- 24. Connotes
- 25. Ens
- 27. His
- 29. Vex
- 31. Iotas
- 33. Mat
- 34. Apia
- 35. Cabs
- 37. Cope
- 38. Wes
- 40. Rip
- 41. Ray.

 ^ ANSWERS IN NEXT WEEK'S ^
 ^ CAROL NEWS ^

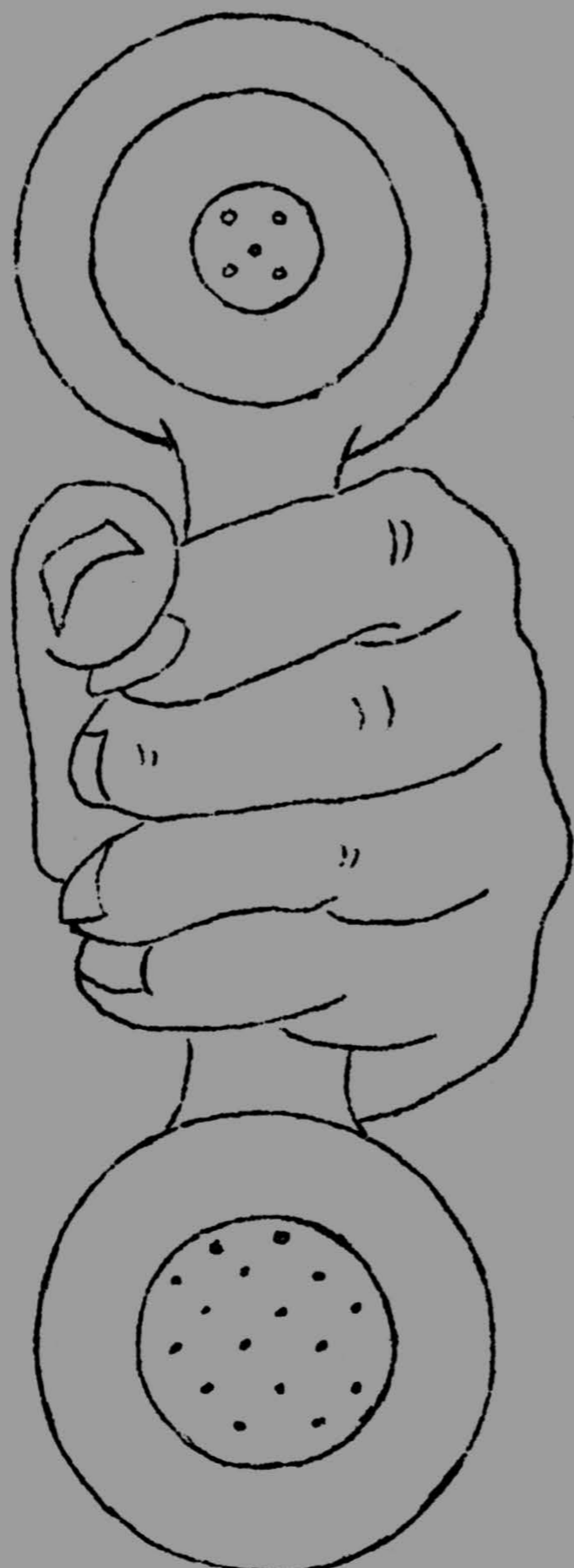

YOUR PHONE IS
THE WAY TO AN
EASY WASHDAY

CALL OUR NUMBER.
YOUR LAUNDRY WILL
BE PICKED UP,
ATTENDED TO, AND
DELIVERED BACK TO
YOU PROMPTLY AND
EFFICIENTLY.

CAROL LAUNDRY DRYCLEANING

944-2226

944-5323

- COMING EVENTS -

- POLAR TOPS:** Will meet as usual on MONDAY evening beginning at 8:00 pm:
- GAMES NIGHT:** The regular night of games will be held in the Roman Catholic Church basement this coming MONDAY evening April 15th at 8:30
- SOCIAL EVENING IN WABUSH:** A Social Evening will take place on WEDNESDAY, April 17th at 8:00 pm: in the Roman Catholic Church Hall in Wabush.
- TRAPSHOOTING:** takes place every SUNDAY at 1:00 pm: at the Skeet Club.
- L.A. BRIDGE & AUCTION:** An evening of Bridge and Auction organised by the Local Association of Guides and Brownies will be held in the Labrador City Collegiate Gymnasium on April 18th. All card enthusiasts are urged to keep this date open and come along to support their local Guides and Brownies.
Raffle tickets are now being sold by the Local Association on an original oil painting by Mr W.W. Archer of Labrador City.
- SKI LODGE DANCE:** A dance will be held at the Ski Lodge on SATURDAY, April 13th beginning at 9:00 pm: Music will be provided by the "NITE BEATS"

PLEASE NOTE: NO DANCE ON FRIDAY.

ASHUANIPI SOCIAL CLUB SCHEDULE:

```

*****
^
^ THURSDAY APRIL 11th: MOVIE NIGHT at 9:00 pm:
^ ' THE FIGHTING PRINCE OF DONEGAL ' starring
^ Susan Hampshire and Peter McEnery (Walt Disney) Coloured.
^
^ GOOD FRIDAY: - CLOSED ALL DAY -
^
^ SATURDAY APRIL 13th: Dancing to the music of the
^ ' RISIN SUNS ' from 8:30 pm:
^
^ SUNDAY APRIL 14th: Dancing to the music of the
^ ' RISIN SUNS ' from 3 - 6 pm:
^
^ MONDAY APRIL 15th: MOVIE NIGHT at 9:00 pm:
^ ' RAW EDGE ' starring Rory Calhoun and Yvonne DeCarlo.
^ ( AN EXCITING WESTERN )
^
^ TUESDAY APRIL 16th: MOVIE NIGHT at 9:00 pm:
^ ' THIRD MAN ON THE MOUNTAIN ' with Michael Rennie and
^ Janet Munro. ( A WALT DISNEY PRODUCTION IN COLOUR )
^
^
^ FRIDAY APRIL 18th: A NIGHT OF GAMES beginning at 9:00pm
^ ( 350 in 53 )
^
^
*****

```

BELIEVE IT OR NOT !

A TIBETAN WOMAN carries all her wealth in jewels and coins sewn into her tshukti, strips of heavy cloth which dangle down her back from her braids to her heels. A prospective suitor can estimate her dowry at a glance.

VON WITT, official hangman of Cape Town, South Africa, always wore dark glasses, a stovepipe hat, and a false beard at executions, in the belief that his own conscience was being fooled by the disguise.

! ALL WORK GUARANTEED !

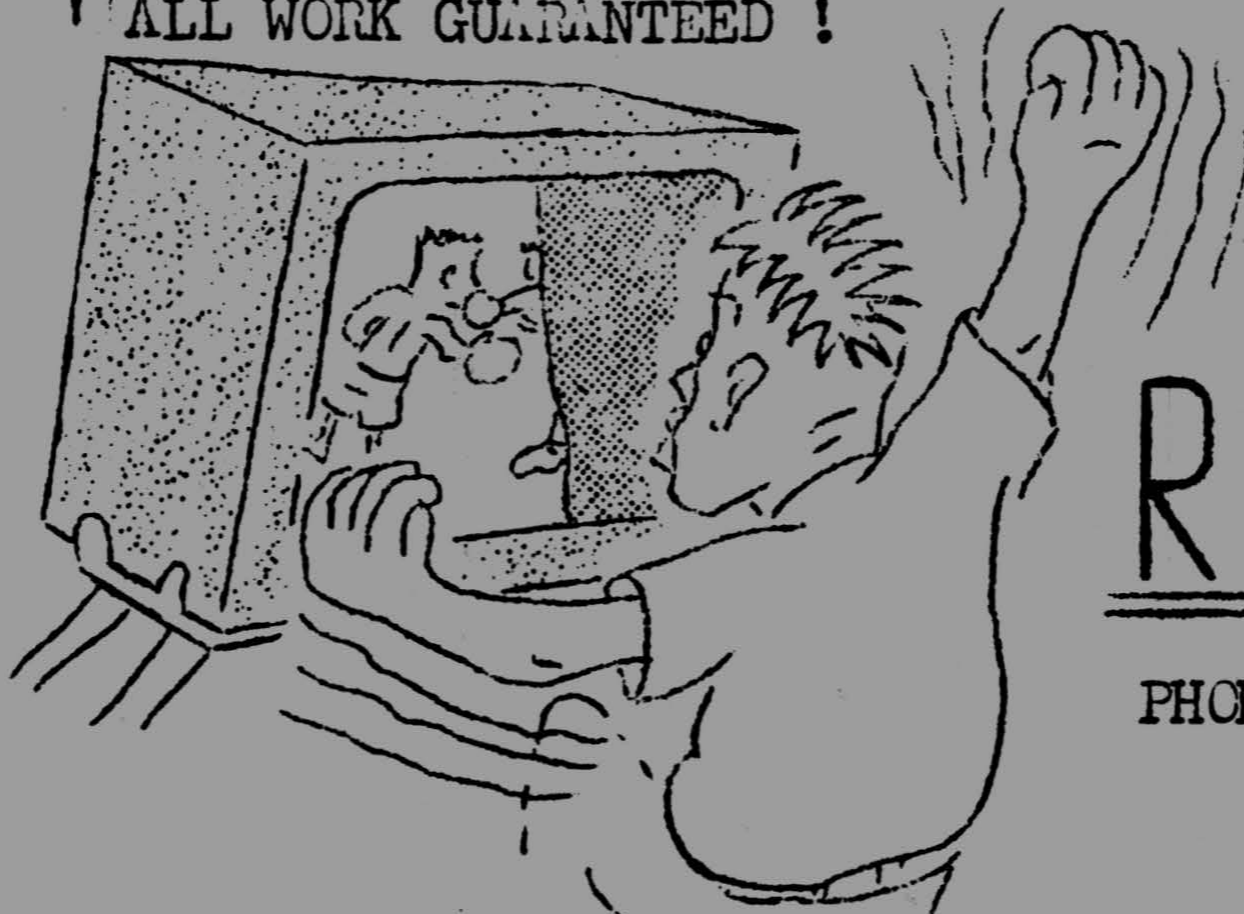

**TV
REPAIR**

RECORD PLAYERS

TAPE RECORDERS

STEREOS

RADIOS

HI - FI

PHONE: TERRY WYATT: 944-2217

MARCEL LYONNAIS: 944-5327.

ETC:

- RECREATION DEPARTMENT SCHEDULE -

Thursday April 11th.	L.C.C.Gym:	Badminton Club	7:00 pm	to	9:00 pm
Saturday April 13th.	School Activities in both gyms:				
Sunday April 14th.	L.C.C.Gym:	Badminton Club	1:30 pm	to	5:00 pm
Monday April 15th.	L.C.C.Gym:	Men's Indoor Soccer	7:00 pm	to	9:00 pm
Tuesday April 16th.	L.C.C.Gym:	Men's Volleyball	7:00 pm	to	9:00 pm
Wednesday April 17th.	L.C.C.Gym:	Men's Volleyball	7:00 pm	to	9:00 pm

- MOSQUITO LEAGUE -

The Mine Service Garage are the 1967/68 Labrador City Mosquito Champions. They earned a berth into the finals by defeating Hussey's Wolves in the semi finals. In the other semi final playoff series the Kinsmen team from Wabush defeated Whitten Fuel Oil and advanced to the finals against Mine Service Garage.

The final game between M.S.G. and the Kinsmen teams was a contest worth watching. At the end of regulation time the two teams were in a scoreless tie and it took 20 minutes of overtime hockey to finally break it. The winning goal finally came off Leonard's stick on an end to end rush.

Congratulations to Bill Todd, coach of the Mine Service Garage team and to all team members !

- PEE WEE LEAGUE -

Congratulations to Pete Lineger and his "Columbians" for winning the Labrador City Pee Wee League Championship ! The Columbians won over Woolworth's (Mosquito All-Stars) in the semi-finals, then advanced to the finals against the Legion.

In the other semi-final series, the Legion team defeated the Kinsmen team to earn a place in the finals. The Columbians came out on top of the Legion team by taking them in two straight games thus claiming the championship for 1967/68.

- BANTAM LEAGUE -

In the Bantam playoffs the Dominion Store team from Wabush got a bye into the finals as a result of a first place finish in the three team league.

The semi-finals saw the Esso Tigers square off against the Lions who downed the Pee-Wee All Stars and earned the right to meet the Dominion Store team in the finals. In this game the Dominion Store team breezed through the finals, taking the series in two straight games.

Congratulations to the 1967/68 Bantam Champions from Wabush and to coach John Delaney for a job well done !

- JUVENILE LEAGUE -

The Northern Sports took the semi finals over the Bantam All Stars in two straight games. In the first game of the series N.S. had no trouble at all with the younger boys as they took an easy 6 - 1 victory. During the second game however, the Bantam outthrustled and out played Northern Sports but had trouble getting the puck into the net, and with only a few minutes left in the game Northern Sports scored the winning goal, winning the contest in two straight games.

In the other semi-final series, Wabush won two games over the Carol Cleaners team. However, the second game was rejected and ordered to be replayed when it was found that the referee was not eligible to referee Juvenile games. This game will be replayed on Wednesday, April 10th, and if a third game is necessary it will take place on April 11th at 5:45 pm:

The local Pee-Wee All-Star team will travel to Grand Falls, Newfoundland to take part in the Newfoundland Provincial Tournament which will be held from April 16th to the 18th: The boys leave Wabush Air Port on the 15th (Monday) at 1:40 pm: and will be returning on Friday April 19th at 2:45 pm:

GAME SCHEDULE

WEDNESDAY APRIL 17th.

9:00 am.	LABRADOR CITY	vs	CONCEPTION BAY SOUTH
2:00 pm.	CORNER BROOK	vs	LABRADOR CITY
5:00 pm.	GANDER	vs	LABRADOR CITY

THURSDAY APRIL 18th.

9:00 am.	ST. JOHN'S	vs	LABRADOR CITY
12:00 noon.	GRAND FALLS	vs	LABRADOR CITY
7:30 pm.	<u>CHAMPIONSHIP GAME</u>		

TEAM LINE UP:	COACH:	DENNIS FURLONG	JOHN KENNEDY
	ASS.COACH:	WALLY KERR	IAN BURFORD
		TOMMY REDDICK	JOHN BULLEN (ASS. CAPTAIN)
		BRUCE BULLEN	ROBERT LUCAS
		LARRY BARTLETT	MICHAEL SURETTE
		TONY FIFIELD	JUNIOR AVERY
		BILLY WEST	GEORGE HUNT
		RONALD HUNT	DAVID GOSSE
	TEAM CAPT.	BRENDAN KERR	MICHAEL SUMNER
		TOMMY COSTIGAN.	

- T.V. SCHEDULE -

MONDAY THROUGH FRIDAY

4:00 4:30 The Edge of Night
 4:30 5:00 Bonny Prudden (unless
 stated otherwise)
 5:00 5:30 Take 30
 5:30 6:00 Bobino
 6:00 6:30 La Boite a Surprises

THURSDAY APRIL 11th

2:00 4:00 The Opening Ceremonies of
 the Liberal Convention.
 6:30 7:00 Upside Town
 7:00 7:30 Let's Go !
 7:30 8:00 Green Acres
 8:00 8:30 Camera '68
 8:30 10:30 N.H.L. PLAYOFFS (GAME 1)
 'BOSTON vs MONTREAL '
 10:30 11:00 Tribute to Prime Minister
 Pearson.
 C.B.C.News

OMITTED: 4:30 pm:to 5:00 pm: 'MANTOVANI '

FRIDAY APRIL 12th

4:00 4:30 ' FELICIA '
 6:30 7:00 Upside Town
 7:00 7:30 Let's Go !
 7:30 8:30 Perdue dans L'espace
 8:30 9:00 Friendship Jamboree
 9:00 9:30 MICHAEL ANGELO
 9:30 10:00 A Matter of Fact
 10:00 11:00 Christ With Us Now
 11:00 11:10 C.B.C.News
 11:10 Late Night Theatre -
 ' HOODLUM PRIEST '
 starring Don Murray, Keir Dullea and
 Larry Gates.

SATURDAY APRIL 13th

2:30 8:30 ELECTION OF LEADERS

 8:30 10:30 N.H.L. Hockey presents -
 ' BOSTON vs MONTREAL '
 10:30 11:00 Les Couche Tard
 11:00 11:10 C.B.C.News
 11:10 Cinema -
 ' AU RISQUE DE SE PERDRE '
 avec Audrey Hepburn et Peter Finch.

SUNDAY APRIL 14th

4:00 4:30 Man Alive
 4:30 5:00 Hymn Sing
 5:00 5:30 La Vie Qui Bat
 5:30 6:00 Les Hommes des L'espace
 6:00 6:30 Frankenstein Junior
 6:30 7:30 The Ed Sullivan Show
 7:30 8:00 Flashback
 8:00 9:00 Les Beaux Dimanches
 9:00 10:00 Bonanza
 10:00 11:00 The Way It Is

MONDAY APRIL 15th

6:30 7:00 Forest Rangers
 7:00 7:30 Let's Go !
 7:30 8:30 Le Paradise Terrestre
 8:30 9:30 Show of the Week
 9:30 10:00 Front Page Challenge
 10:00 11:00 In Person
 11:00 11:10 C.B.C.News.

TUESDAY APRIL 16th

3:30 4:00 Canadian School Telecast
 6:30 7:00 Upside Town
 7:00 7:30 Let's Go !
 7:30 8:30 The Carol Burnett Show
 8:30 10:30 N.H.L. HOCKEY PLAYOFFS.
 10:30 11:00 The Public Eye
 11:00 C.B.C.News

WEDNESDAY APRIL 17th

6:30 7:00 Upside Town
 7:00 7:30 Let's Go !
 7:30 8:00 D'Iberville
 8:00 8:30 Moi et L'autre
 8:30 9:30 Mission Impossible
 9:30 11:00 Festival
 11:00 C.B.C.News.

~ ~ ~ ~ ~
 ^ THIS T.V. SCHEDULE IS SUBJECT ^
 ^ TO CHANGE WITHOUT ANY NOTICE: ^
 ~ ~ ~ ~ ~

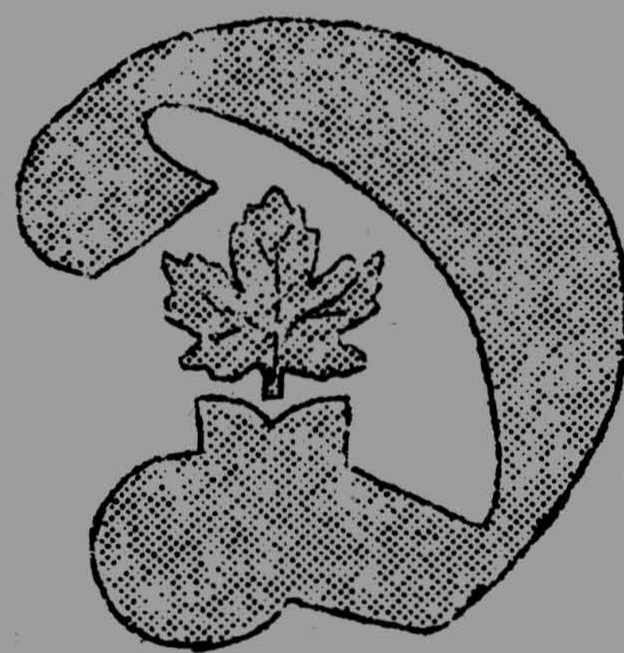

DOMINION
STORES

SHOP AT YOUR FRIENDLY DOMINION STORE

ARRETES A VOTRE MAGASIN DOMINION

AND REMEMBER

ET SOUVENEZ VOUS

"IT'S MAINLY BECAUSE OF THE MEAT"

"C'EST SOUTOUT A CAUSE DES VIANDES"

FOR FURTHER INFORMATION ON OUR

DES SPECIAUX

SPECIALS

VOYEZ LA BROCHURE QUE SERA

SEE THE BROCHURE WHICH IS BROUGHT

DELIVREE A VOTRE PORTE

TO YOUR DOOR

Labrador City:

Wabush:

HAPPY EASTER SPECIALS

APRIL 11TH, 13TH

EGGS-MEDIUM SIZE
49¢ DOZ

DREAM WHIP
4 OZ 59¢

PAPER NAPKINS
100 39¢

YOUVILLE 24 OZ
STRAWBERRY 47¢
JAM



"GREEN GIANT"
PEAS
15 OZ 4 / \$1-00

CHASE & SANBORN INSTANT COFFEE
10 OZ \$1-69

B C RED APPLES
6 / 55¢

FRESH PICNIC
HAM
49¢ lb

LETTUCE ICEBERG
35¢

WILSIL BACON
SUGAR CURED
79¢

FRESH PINEAPPLE
(LARGE)
49¢

ASS'T'D COLD MEATS
6 OZ 3 / 89¢

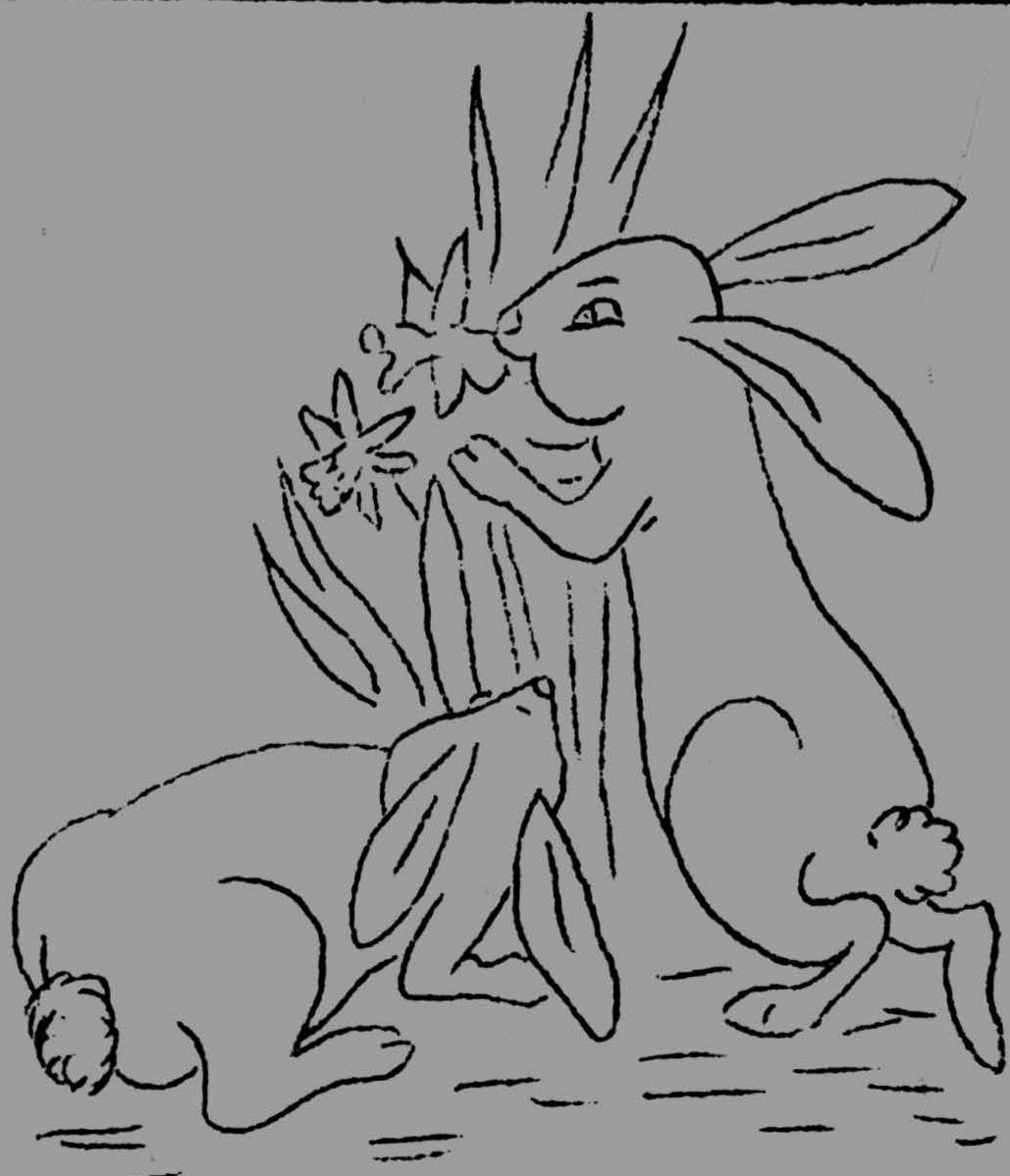

BOWRINGS