

*Audrey Sumner:*

# CAROL NEWS

VOLUME 3

ISSUE 22

BOX 1813

LABRADOR CITY MARCH 21st 1968

AUTHORIZED AS SECOND CLASS MAIL BY THE POST OFFICE DEPARTMENT , OTTAWA AND FOR  
PAYMENT OF, POSTAGE IN CASH

## ANOTHER STEP FORWARD ?

Medical history was made or at least it seems so, when, on Saturday, March 16th 1968, Dr. Philip Blaiberg walked out of the Grootc Schuur Hospital in Capetown, South Africa, the sole survivor of a series of six heart-transplant operations performed in three different countries.

Dr. Blaiberg has been confined in germ-free quarters in the hospital and with his discharge from hospital, there now begins another stage in his recovery and in his bodies acceptance of another heart. Can he continue to thrive under normal living conditions, germs and all ?

By his side has been, was, and we are sure will be for some time to come, the man who performed the operation, Dr. Christian Barnard, whose name is sure to go down in history.

With strides like these being made in medicine, science, etc, we wonder what life will be like in another 100 years.

---

## NOTE OF THANKS

I would like to take this opportunity of thanking Mrs. Verna Sheppard and Bernard and Hazel Waddington for all their help in the publication of the Carol News while I was in hospital. Without them the paper would not have reached you.

Audrey Sumner.

---

## INSIDE YOUR CAROL NEWS

CHURCH CALENDAR  
DON'S SPORTS BEAT  
T.V. SCHEDULE

ADVERTISING  
X-WORLD

COMING EVENTS  
CHIT CHAT  
PERSONAL ADS.



COME TO CHURCH  
ON  
SUN MAR. 24<sup>TH</sup>

PENTECOSTAL CHURCH - GLAD TIDINGS  
TABERNACLE. Pastor B.H.Hartwell.

11:00 am Morning Worship  
3:00 pm Sunday School  
7:30 pm Evangelistic Service

MIDWEEK GROUPS: THURSDAY (tonight March 21st- Young Peoples Service 8:00 pm  
MONDAY March 25th. Womens Missionary Council 8:00 pm  
TUESDAY March 26th. Prayer Service 8:00pm.

ST. PAUL'S ANGLICAN CHURCH  
Rev. L. Whitten

THURSDAY (tonight March 21st) Junior Choir practice at 6:30 pm:

SUNDAY March 24th.  
8:30 am Holy Communion  
9:45 am Sunday School  
11:00 am Morning Prayer  
7:00 pm Evening Prayer

WEDNESDAY March 27th.  
Lenten Evening Service at 7:30 pm.

CHRIST CHURCH - WABUSH (SERVICE:Upstairs)  
Rev. Blake Walker. (in Recreation Centre)

SUNDAY March 24th.  
9:45 am Sunday School  
11:00 am Morning Worship  
7:00 pm Evening Worship

4:30 pm Senior Teens (30, Bond Avenue)

BUILDING PROJECT:

After Supper - Tuesday, Wednesday and Thursday.  
During the Day on Saturday.

ST. PETER'S ANGLICAN CHURCH - WABUSH

Rev. L. Whitten.

FRIDAY March 22nd

Lenten Evening Service 7:30 pm.

SUNDAY March 24th.

11:00 am Sunday School  
7:00 pm Evening Prayer

OUR LADY OF PERPETUAL HELP

Rev. O. Desmarais  
Rev. F. Lemire

9:00 am Mass  
11:00 am Mass  
5:00 pm Mass (French)  
7:00 pm Mass

WEEKDAYS: 5:15 pm Mass.

OUR LADY OF THE ASSUMPTION - WABUSH

Rev. J. Bergeron

10:00 am Mass  
7:00 pm Mass

WEEKDAYS: 5:00 pm Mass (excepting on Fridays when Mass will be celebrated at 3:30 pm:)

CAROL UNITED CHURCH

Rev. Eric Snider.

9:30 am Sunday School for Junior 9-11 yrs & Intermediates 12-15 yrs.  
11:00 am Morning Worship and Holy Baptism.  
(Kindergarten 5 yrs and under  
Cradle Roll 2 yrs and under )  
2:30 pm Primary Sunday School 6-8 yrs.  
7:15 pm Song Service  
7:30 pm Evening Service.

MIDWEEK GROUPS: As usual, with Junior Choir practice now taking place on Saturday at 7:00 pm:

SALVATION ARMY CITADEL

Captain J. Carew

11:00 am Holiness Meeting  
2:30 pm Sunday School  
7:30 pm Evangelistic Meeting

WEDNESDAY March 27th. Band Practice 8:15pm

GOOD are the things we cannot buy:  
Eyes that may see a bright blue sky,  
Ears that may catch the voice of spring,  
Strength for the tasks each day will bring;  
Love and laughter - an appetite,  
Sleep that blesses us in the night;  
Courage to dare and wit to try. . .  
Priceless possessions none can buy.

PERSONAL ADS

FOR SALE

1965 Meteor Motor - Avenger 6 - low mileage.

Siamese Kittens (registered & house trained)

1 Schubert Piano (almost new) \$800 or nearest offer )

1 Gibson Guitar(2 months old) \$125 or nearest offer. )

1965 Ford Fairlane, automatic, 6 cylinder.

Motor Ski for sale, price \$250.

1 Chesterfield and 2 chairs

PLEASE RING

944 - 2606 during the day

944 - 5243 after 6:00 pm:

944 - 2187

) 944 - 3322

944 - 2271

944 - 5684

944 - 5290 after 5:00 pm:

WANTED TO BUY:

A vacuum cleaner in good condition.

944 - 5623

LOST:

A cat approximately one year old. Black with white neck - part Persian. Finder please ring

944 - 2043 or 944-3334

Grey and black fox fur hat with name: 'ELAINE HERBERT' printed inside. Lost between restaurant and Guy Street on Sunday last. Finder please ring

944 - 5685 (REWARD OFFERED)

ACCOMODATION AVAILABLE:

I can accomodate 1 female boarder

944 - 5760

Room for rent for couple without children

944 - 5186

ACCOMODATION REQUIRED:

Couple require house, apartment or trailer to rent. 944 - 5653

Couple without children require apartment, house or trailer.

) 944 - 2606 during the day.

) 944 - 2295 evenings.

SERVICES:

Lady willing to do simple sewing, darning, mending, knitting etc: in her home.

944 - 5524

-----  
- SIMPLE RECIPES TO CUT OUT AND KEEP -  
HOT CROSS BUNS

INGREDIENTS:

- 1 lb flour
- 1 level tsp. salt
- 1 oz. yeast
- 3 oz caster sugar
- 1/2 pint milk or milk and water (approx)
- 1/4 tsp. cinnamon
- 1/4 tsp. grated nutmeg
- 4 oz currants
- 1 oz. chopped peel
- 2 oz. melted margarine
- 1 egg
- Milk and sugar to glaze.

METHOD

Sieve together flour & salt. Cream the yeast with 1 tsp. of the caster sugar, add tepid liquid, pour into well in centre of flour and sprinkle a little of the flour. Cover bowl and put in warm place for about 15 mins, till yeast begins to work. Add all ingredients, mix well, adding more milk if required. Cover, put in warm place for approx 1 hr, until double its bulk. Form dough into buns, put on greased tins and cut a cross in the top of each. Put to prove for 15 mins, then brush buns over with milk and sugar go glaze.

BAKE: in a hot oven (450° F. for about 15-20 minutes.

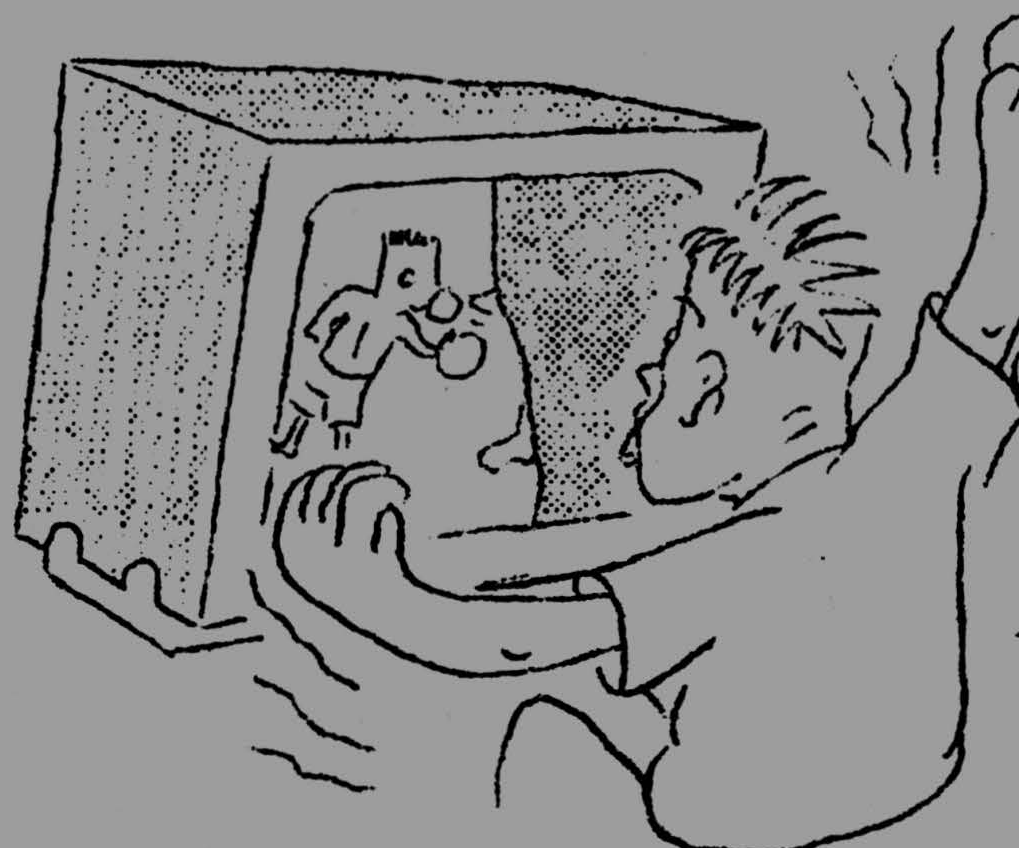

T.V. REPAIR

- RECORD PLAYERS
- STERIO
- TAPE RECORDERS
- RADIOS
- HI - FI etc:

SERVICE: DAY & NIGHT  
ALL WORK GUARANTEED

PHONE: MR TERRY WYATT : 944 - 2217 OR M. MARCEL LYONNAIS : 944 - 5327.

GALLIX SKI-MEET

March 9 - 10/68

	D.H.	SLALOM	G.SLALOM	COMBINED
MEN SENIOR (18 and over)	1	John Krats	Manfred Muenzel	D.Mattinson
	2	Dave Mattinson	John Krats	D.Mattinson
	3			
LADIES SENIOR (18 and over)	1	Carol Sheppard	Carol Sheppard	C.Sheppard
	2		Eleanor Magny	E.Magny
	3	Eleanor Magny		
BOYS JUNIOR A (16 to 18)	1			
	2			
	3		D.Morrisette	
GIRLS JUNIOR A (16 to 18)	1		D.Hardie	
	2	D.Hardie	D.Hardie	D.Hardie
	3			
BOYS JUNIOR (14 to 16)	1	David Dunkin		D.Dunkin
	2		D.Dunkin	D.Batson
	3	Don Batson		D.Batson
GIRLS JUNIOR (14 to 16)	1			
	2	Joan Hardie		J.Hardie
	3			
BOYS JUNIOR C (12 to 14)	1	Bob Archer	Bob Archer	Bob Archer
	2	Kall Swierkot	K.Swierkot	K.Swierkot
	3		R.Timmins	
GIRLS JUNIOR C (12 to 14)	1		Cathy Plue	
	2			
	3	Cathy Cunningham		
BOYS JUNIOR D (UNDER 12)	1		P.Spitznagel	
	2	Perry Spitznagel	B.Dunkin	B.Dunkin
	3		R.Jardin	P.Spitznagel R.Jardin
GIRLS JUNIOR D (Under 12)	1			
	2	R.Hardie		
	3		Robin Hardie	R.Hardie
		SMOKEY MOUNTAIN	-	132 POINTS
		GALLIX	-	130 POINTS.

A NOTE OF THANKS

On behalf of the many children who attend the hospital for needles etc., and for those of them who are patients, I would like to say a big THANKYOU to F.W. WOOLWORTHS STORE and to MR. EDWARDS in particular for the generous gift of candies, chocolates, suckers etc:

NURSE BURFORD  
(for the children)

CONGRATULATIONS: to Marion Smith, 17 year old daughter of Mr & Mrs Moses Smith of Labrador City, who was crowned Queen on March 9th at the St.John's Boy's College,Nfld: Marion is a first year student at Memorial University.

BEST WISHES FROM ALL HER FRIENDS

The Wedding took place on Thursday March 14th in the Carol United Church of FLORENCE ABBOTT and HOWARD GREEN, both of Labrador City. The bride was given away by MR.BAXTER TULK and was attended by MRS.ANNE MOSS & BETTY LOU THOENE. The groom was attended by Mr Ian Moss, Mr Gary Arnold and Mr Patrick Drake. After their honeymoon the newly weds will be residing at 843 Hudson Drive.

THE BAPTISM TOOK PLACE AT ST.PAUL'S ANGLICAN CHURCH LAST SUNDAY, MARCH 14th OF MICHAEL CAMERON PELLEY son of MR.& MRS. HARRY PELLEY OF LABRADOR CITY.

- WELCOME BACK -

THE MANY FRIENDS OF MRS MARY CONDON WOULD LIKE TO WISH HER A WARM WELCOME HOME FROM HER SHORT VISIT HOME TO BONNIE SCOTLAND.

- COMING EVENTS -

POLAR TOPS: will meet as usual on MONDAY evening beginning at 8:00 pm:

GAMES NIGHT: The regular night of games will be held in the Roman Catholic Church basement this coming MONDAY evening, March 25th beginning at 8:30 pm: (\$800 in 54)

SOCIAL EVENING IN WALUSH: will take place on WEDNESDAY, March 27th beginning at 8:00 pm: in the Roman Catholic Church hall in WALUSH.

TRAPSHOOTING: takes place every SUNDAY at 1:00 pm: at the Skeet Club.

SMOKEY MOUNTAIN SKI LODGE: A dance will take place in the Smokey Mountain Ski Lodge on FRIDAY, March 22nd. Dancing from 9:00 pm until 1:00 pm: Music by the 'D.J's' - MEMBERS ONLY.

HIGH SCHOOL DRAMA FESTIVAL: THE STUDENTS OF THE LABRADOR CITY COLLEGIATE WILL PRESENT A HIGH SCHOOL DRAMA FESTIVAL ON THE EVENING OF MARCH 27th IN THE COLLEGIATE AUDITORIUM. THE CURTAIN WILL GO UP AT 8:00 pm: AND TICKETS MAY BE OBTAINED EITHER FROM THE STUDENTS OR AT THE DOOR. TICKETS: ADULTS \$1.00 STUDENTS 50¢.

L.A. BRIDGE & AUCTION: There will be an evening of BRIDGE & AUCTION organised by the Local Association of Guides and Brownies on APRIL 18th. in the Labrador City Collegiate Gymnasium. ALL CARD ENTHUSIASTS ARE URGED TO KEEP THIS DATE OPEN AND SUPPORT THEIR LOCAL GUIDES & BROWNIES BY ATTENDING THIS FUNCTION.

- - - - -  
Raffle tickets are now being sold by the L.A. on an original oil painting by Mr. W.W. Archer of Labrador City.

ASHUANIPI SOCIAL CLUB: THURSDAY MARCH 21st: Movie Night at 9:00 pm: ' THE LCST WORLD ' starring Michael Rennie & Jill St. John. FRIDAY MARCH 22nd: Night of Games commencing at 9:00 pm: ( \$325 in 52 ) SATURDAY MARCH 23rd: Dancing to the Music of the "RISIN SUNS" beginning at 8:30 pm: SUNDAY MARCH 24th: Dancing to the Music of the "RISIN SUNS" from 3:00 pm to 6:00 pm: TUESDAY MARCH 26th: Movie Night at 9:00 pm presents - " NEVER SAY GOODBYE " starring Rock Hudson and George Sanders. THURSDAY MARCH 28th: Movie Night at 9:00 pm presents - " GOODBYE CHARLIE " with Tony Curtis & Debbie Reynolds.

ASHUANIPI SOCIAL CLUB SPECIAL ANNOUNCEMENT: GENERAL MEETING AN EXTRAORDINARY GENERAL MEETING OF MEMBERS OF THE ASHUANIPI SOCIAL CLUB WILL BE HELD ON MARCH 27th BEGINNING AT 7:30 pm IN THE CLUB LOUNGE. THE PURPOSE OF THE MEETING IS TO CONSIDER THE POSSIBLE EXPANSION OF THE PRESENT CLUB BUILDING AND SERVICES TO INCLUDE DINING FACILITIES. BOARD OF DIRECTORS: ASHUANIPI SOCIAL CLUB.

944 - 2758

P.O. BOX 676

LABRADOR CITY

PROTECTION OF EVERY DESCRIPTION  
FIRE AUTO SKIDOO MARINE LIFE DISABILITY

RAY HAMMOND

Representative for

**TOMLINSONS INSURANCE**

944 - 2758

P.O. BOX 676

LABRADOR CITY.

# ELECTROLUX

(CANADA) LTD

THE WORLD'S MOST IMITATED  
CLEANER AND THE WORLD'S ONLY  
FULLY AUTOMATIC CLEANER.....

THE  
ZB 88

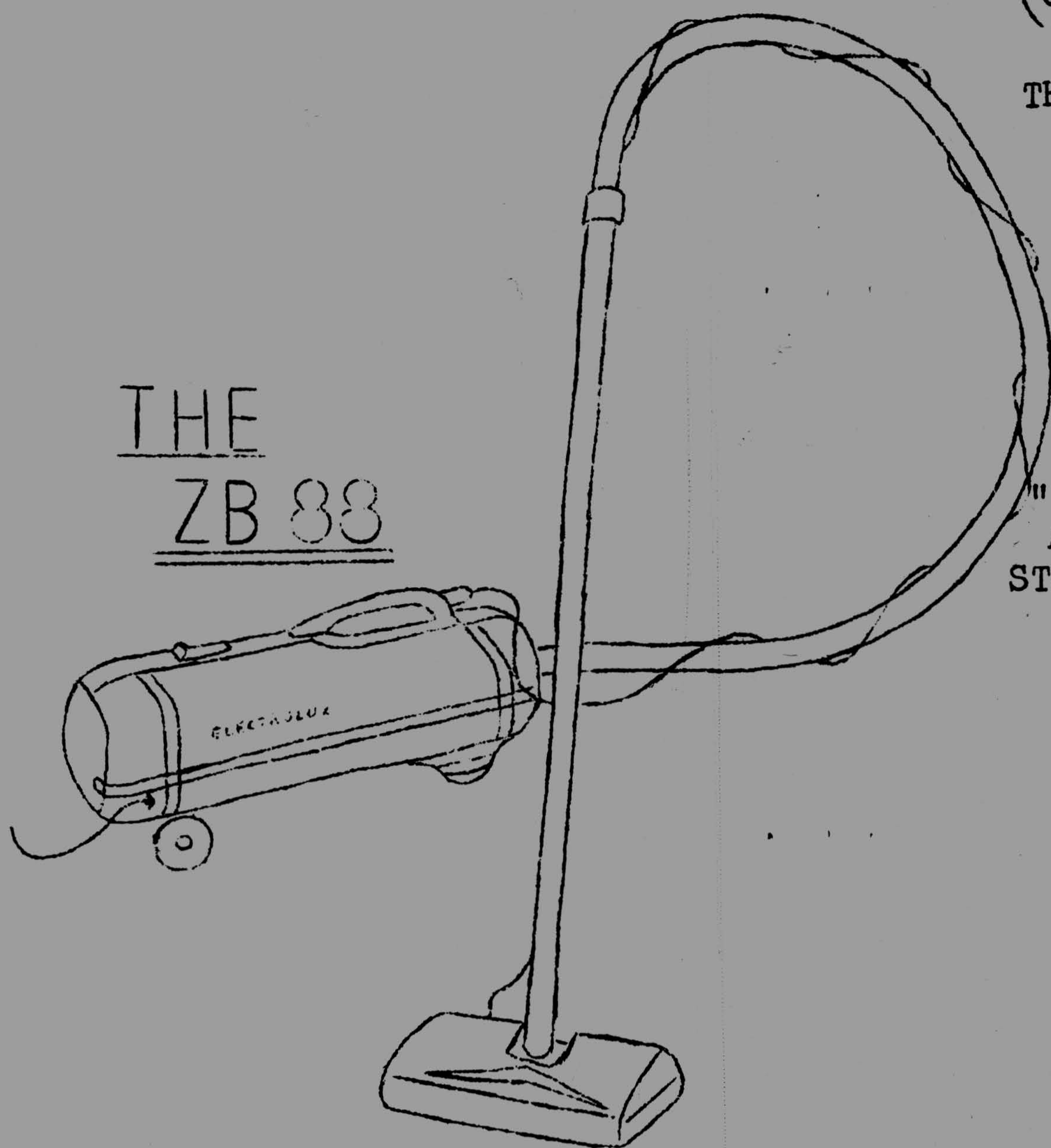

-----  
FEATURING THE FAMOUS  
Z B. 88 VACUUM  
CLEANER WITH THE  
" POWER NOZZLE "  
AND AN OPTIONAL  
STOWAWAY CHEST.

ALSO THE LATEST FLOOR AND RUG  
CONDITIONER - THE BX 20 FLOOR  
POLISHER, WHICH SCRUBS YOUR  
FLOORS, SHAMPOOS YOUR RUGS,  
AND POLISHES YOUR FLOOR, ALL  
WITH THE SAME MACHINE.

-----  
YOU WOULD HAVE TO SEE THIS  
WONDERFUL MACHINE TO FULLY  
APPRECIATE ITS VALUE.



THE  
BX 20

YOUR ELECTROLUX REPRESENTATIVE IN LABRADOR  
CITY WILL BE PLEASED TO GIVE YOU A FREE  
DEMONSTRATION.

WHY NOT GIVE ME A CALL, AND TAKE ADVANTAGE  
OF OUR VERY EASY TERMS???

WE HAVE IMMEDIATE DELIVERY, AND STOCK EVERY-  
THING FOR YOUR FUTURE NEEDS.

FOR MORE INFORMATION - PLEASE CALL:..... 944 - 2215 or 944 - 2361

A FULL 2-YEAR GUARANTEE ON

ALL OUR PRODUCTS

ELECTROLUX REPRESENTATIVE  
FOR LABRADOR CITY & WABUSH

LEN LEYTE

SMOKEY MOUNTAIN SKI CLUB

Members are reminded that their MEMBERSHIP IS NOT TRANSFERABLE. Use of your membership card or privileges by a non-member will bring IMMEDIATE CANCELLATION OF YOUR MEMBERSHIP.

Out-of-town guests and prospective members ARE WELCOME WHEN THEY ARE SPONSORED BY A MEMBER. PLEASE APPLY TO THE MANAGER, MR BOB CROOK or ANY DIRECTOR: WABUSH: Mr. A.M.McKim(President) 3 Reid St.282-6256

LABRADOR CITY: Mr.Leo Meewis (Vice-President) 127,Cabot 944-5109  
Mr.K.R.Kilburn (Secretary) 310 Carol 944-5403  
Mr.H. Bosche 944-5173  
Mr.Ray Crook, 944-5212  
Mrs.Janet Krickler 944-3344  
Mrs.Pat McGuire 944-3331  
Mr.Dave Mattinson 944-8328  
Dr.Kira Obrazcova 944-2951  
SKI LODGE: 944-7767

Physical Fitness  
Division:

GOVERNMENT OF NEWFOUNDLAND & LABRADOR  
Department of Provincial Affairs

ST.JOHN'S

The Hon.Dr.G.M.Frecker, Minister of Provincial Affairs, announced today that the Physical Fitness Division will be sponsoring a Conference on Amateur Sport on April 26 and 27, 1968 in St.John's. The purpose of the conference is three-fold:

- (1) to inform the Amateur Sports Governing Bodies of policies concerning amateur sport now in effect at the National and Provincial levels.
- (2) to discuss problems of common concern affecting amateur sport in Newfoundland and ways of solving these problems, and
- (3) to establish policies and procedures which will assist in the general promotion of Fitness and Amateur Sport through the Province.

The Physical Fitness Division is now in the process of contacting various sports organizations to ascertain if they wish to participate in this Conference.

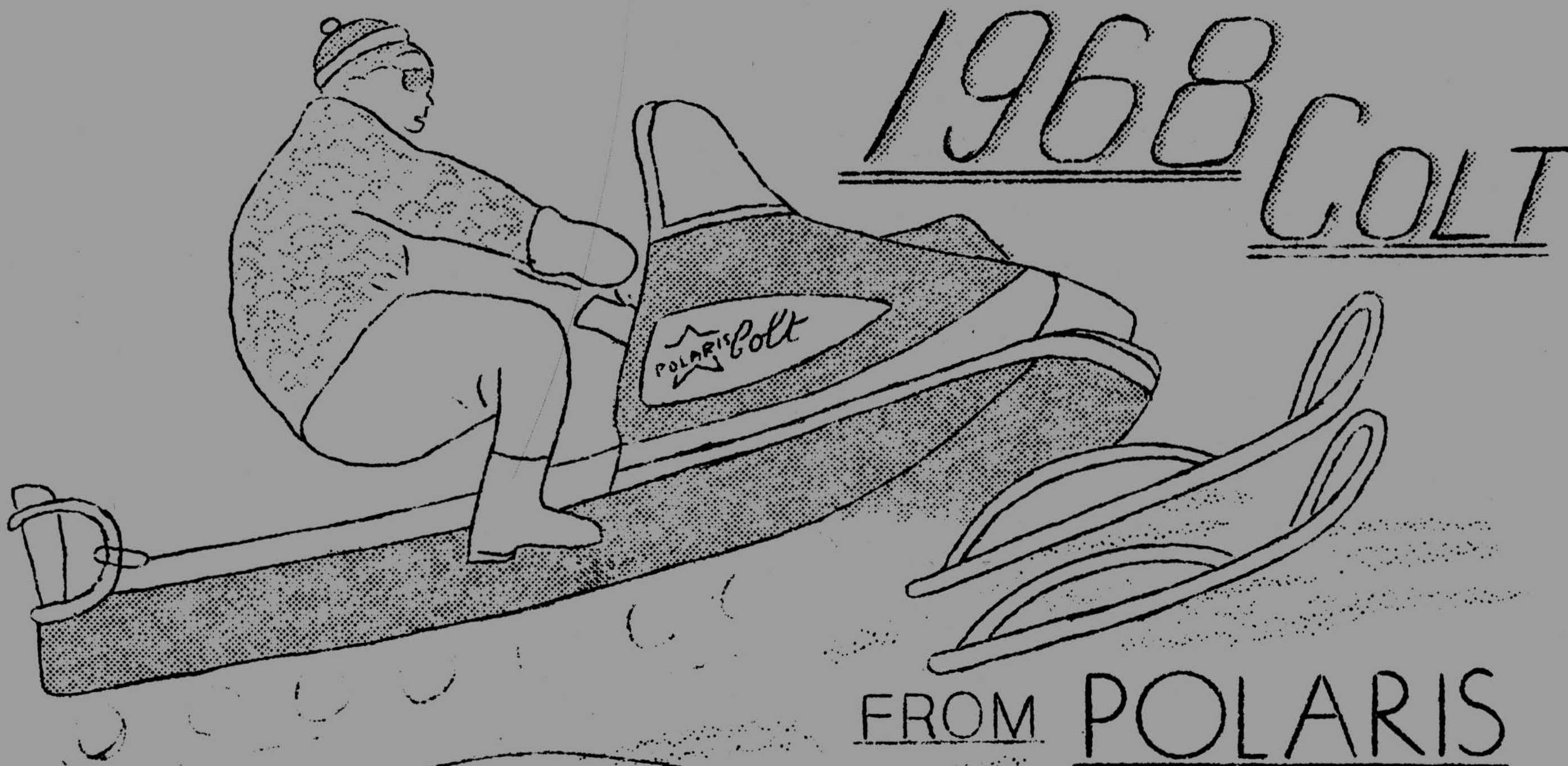

=== NOW TO CLEAR STOCK ===

ONLY "1" LEFT GOING AT BELOW  
COST

YOUR LAST CHANCE TO ACQUIRE A  
DEPENDABLE SNOWMOBILE AT BARGAIN  
BASEMENT PRICE

944-  
2021

LABRADOR DISTRIBUTORS LTD

944-  
3337

ORTHODONTIST:

Dr. Brett Williams will be in Labrador City Dental Office on March 29th and 30th. For appointments call DR. OBRAZCOVA at 944 - 5445 between 9:00 am - 12:00 noon and 1:00 pm - 5:00 pm:

-----

THE WELL BABY CLINIC:

The Well Baby Clinic will be held on the 27th March (Wednesday) in the Wabush Clinic situated at the end of Bunkhouse 3 on Whiteway Drive.

CLINIC HOURS:

AFTERNOON: FROM 1:00 to 2:00 pm:  
EVENING: " 7:00 to 8:00 pm:

These clinics are FREE and are sponsored by the Wabush Red Cross.

-----

LOCAL STUDENTS TO ST. JOHN'S: CONFERENCE ON FRENCH-ENGLISH RELATIONS:

A group of students from Labrador City and Wabush attended a French-English Relations conference for high school students in St. John's on March 16th & 17th. The purpose of the conference was to examine various aspects of French-English Relations in Canada. A few topics discussed were:-

- (1) Will Canada survive ?
- (2) What do the French Want ?
- (3) Should you be bi-lingual ?
- (4) Can you help Canada ?

The trip was sponsored by the Government of Newfoundland and Labrador and the local school boards.

-----  
A Montreal man, lately divorced, decided to give marriage another try and being a true believer in the electronic age completed the very elaborate questionnaire necessary to find a new wife by computer.

His card was duly fed into the machine which searched through more than 15,000 files and came up with 5 names who would make suitable wives for him, according to the qualifications he himself had set down.

Heading the list was the name of his former wife, who had also filled in her own questionnaire for the computer! ! ! !

SIR WILFRED GRENFELL  
HOTEL

FRIDAY NIGHT UNTIL FURTHER

NOTICE:—

DANCING NIGHTLY

TO THE MUSIC OF

MIKE BRETZ

AT THE ORGAN

WE ARE CONSTRUCTING A  
NEW DANCE FLOOR IN THE  
LOUNGE FOR YOUR ADDED  
ENJOYMENT



# X-WORD PUZZLE

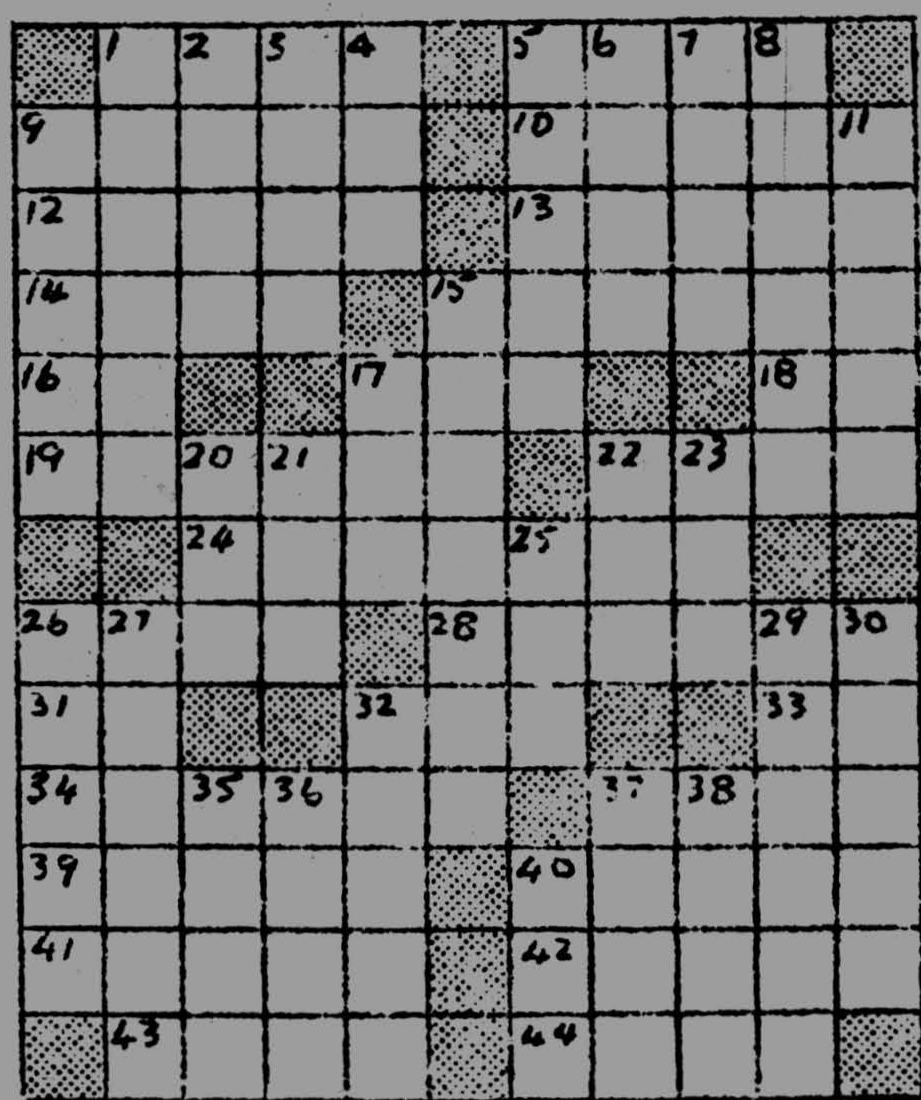

ACROSS

DOWN

- |                         |                        |
|-------------------------|------------------------|
| 1. Glide                | 1. Smudgy              |
| 5. Strike               | 2. Precious stone      |
| 9. Abundant             | 3. Charity             |
| 10. Stogie              | 4. Legal matter        |
| 12. Quantities of paper | 5. Stunted tree        |
| 13. Lift                | 6. Prevaricator        |
| 14. Guys' companions    | 7. Exchange premium    |
| 15. Glum                | 8. Annie Oakleys       |
| 16. Biblical city       | 9. Giant with 100 eyes |
| 17. Large               | 11. Staggers           |
| 18. Overhead train      | 15. Ore                |
| 19. Forestlike          | 17. Cornwall mine      |
| 22. Game fish           | 20. Budhist pillar     |
| 24. Aircraft part       | 21. Struggle           |
| 26. Tardy               | 22. Bravura jazz       |
| 28. River current       | 23. Blackbird          |
| 31. Bovine              | 25. Beam               |
| 32. Islet               | 26. Earths             |
| 33. What?               | 27. Crown vetch        |
| 34. Starry              | 29. Staid              |
| 37. Dancer              | 30. Lean-tos           |
| 39. Pools               | 32. Packing boxes      |
| 40. Audibly             | 35. Threesome          |
| 41. Fishing net         | 36. Hire               |
| 42. Bellows             | 37. Genus of lily      |
| 43. Specks              | 38. Burden             |
| 44. Give over           | 40. Rainbow            |

ANSWERS TO MARCH 14th  
X-WORD.

- | <u>Across</u> |             | <u>Down</u> |             |
|---------------|-------------|-------------|-------------|
| 1. Wasp       | 23. Booty   | 1. Wider    | 22. Fray    |
| 5. Flap       | 26. Brass   | 2. Andes    | 23. Biform  |
| 9. Tinea      | 27. Inns    | 3. Sea      | 24. Onerous |
| 10. Rills     | 28. Ria     | 4. Pax      | 25. One     |
| 12. Addax     | 29. Fee     | 5. Frill    | 26. Bin     |
| 13. Impel     | 30. Canyons | 6. Limy     | 28. Ray     |
| 14. Ree       | 34. Or      | 7. Alp      | 30. Chess   |
| 15. Ply       | 35. Shy     | 8. Pleases  | 31. Ohios   |
| 16. Ao        | 36. Hia     | 9. Tara     | 32. Nimes   |
| 17. Arsenal   | 37. Route   | 11. Slopes  | 33. Sass    |
| 20. Asp       | 39. Mains   | 15. Pan     | 35. Stem    |
| 21. Fan       | 41. Mules   | 18. Efts    | 38. Ulu     |
| 22. Free      | 42. Aloes   | 19. Nay     | 39. Mat     |
|               | 43. Sums    | 20. Ara     | 40. Ala     |
|               | 44. Tass    |             |             |

ANSWERS: IN NEXT WEEK'S CAROL NEWS

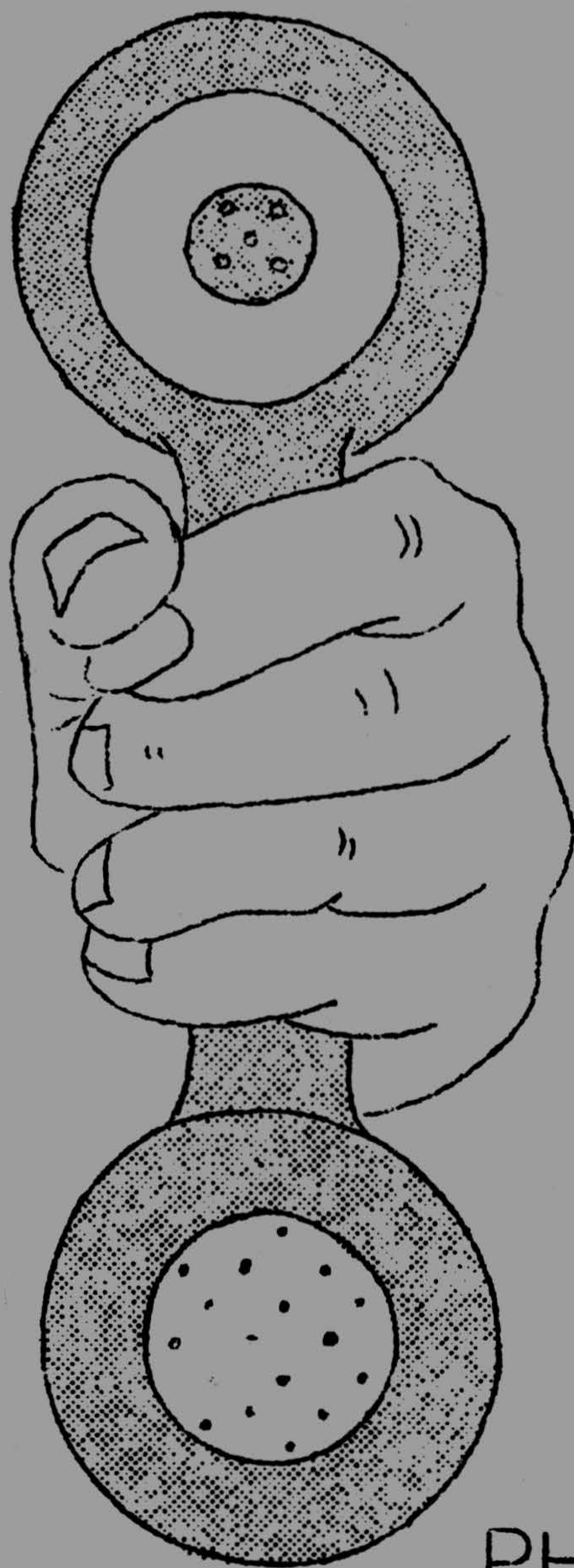

YOUR PHONE IS  
THE WAY TO AN  
EASY WASHDAY

CALL OUR NUMBER AND  
YOUR LAUNDRY WILL  
BE PICKED UP ATTENDED  
TO AND DELIVERED BACK  
TO YOU PROMPTLY AND  
EFFICIENTLY

PHONE 944-2226 OR 944-5323

CAROL LAUNDRY DRYCLEANING

# BARGAINS !!!!! BARGAINS

## SPACE SAVERS

IDEAL WHEN  
YOU NEED  
THAT EXTRA BED

\$69-99

## BABIES MESH

PLAYPENS

\$34-99

PACKAGE OF 2

TWIN PACK PILLOWS \$2-88

## BLOUSE SPECIAL

LADIES PERMANENT PRESS BLOUSES

REG \$2-99

NOW

\$1-88

## JUST ARRIVED

"PHENTEX" KNITTING WOOL. 100% CELASPUN  
PRICED ACCORDING TO WEIGHT.

PATTERN  
BOOKS 20¢

## FRIDAY NIGHT SPECIAL

7pm  
9pm

A WIDE SELECTION OF

MENS SPORTS  
SHIRTS

1/2 PRICE

# WOODWARD'S

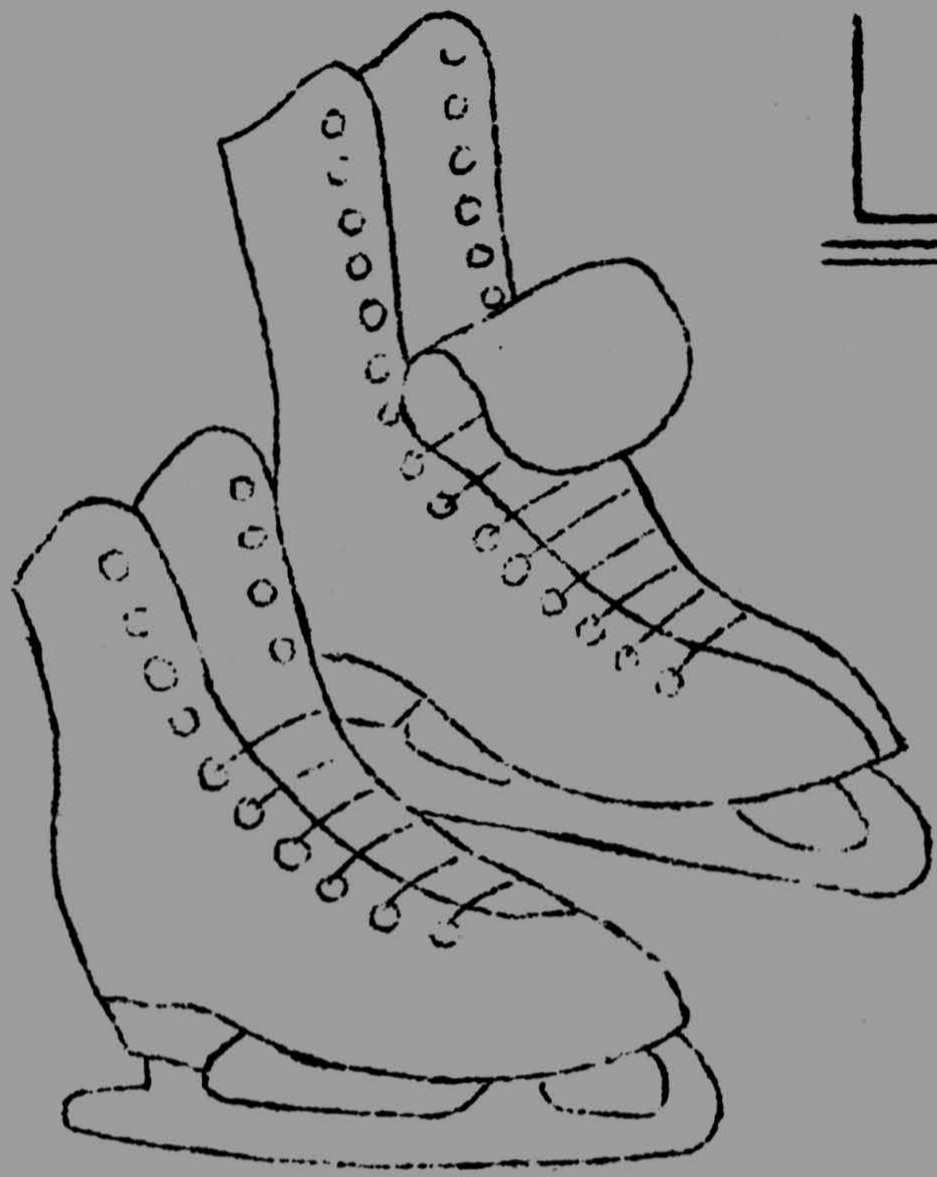

# LABRADOR CITY ARENA

## WEEKLY SCHEDULE

THURSDAY MARCH 21st.	LADIES & TOTS SKATING	10:00 am		
	MINOR HOCKEY	4:45 pm	to	6:45 pm
	BROOMBALL			
	MILL vs BRAVES	7:30 pm		
	WABUSH vs AVENGERS	9:00 pm		
FRIDAY MARCH 22nd	CASUAL RENTALS	8:00 am	to	4:00 pm
	MINOR HOCKEY	4:45 pm	to	6:45 pm
	BRAVES PRACTICE	7:00 pm	to	8:00 pm
	BROOMBALL			
	WARLOCKS vs ROYALS	8:15 pm		
	ROCKETS vs LAB.	9:30 pm		
SATURDAY MARCH 23rd.	MINOR HOCKEY	8:00 am	to	1:00 pm
	PUBLIC SKATING	2:00 pm	to	4:00 pm
	FIGURE SKATING	4:30 pm	to	6:00 pm
	PUBLIC SKATING	8:30 pm	to	10:30 pm
SUNDAY MARCH 24th.	CASUAL RENTALS	8:00 am	to	1:00 pm
	PUBLIC SKATING	2:00 pm	to	4:00 pm
	MINOR HOCKEY	4:30 pm	to	6:30 pm
	BROOMBALL	7:00 pm		
	BRAVES vs AVENGERS			
	PUBLIC SKATING	8:30 pm	to	10:30 pm
MONDAY MARCH 25th	CASUAL RENTALS	8:00 am	to	4:00 pm
	MINOR HOCKEY	4:45 pm	to	6:45 pm
	BRAVES PRACTICE	7:00 pm	to	8:00 pm
	PUBLIC SKATING	8:30 pm	to	10:30 pm
TUESDAY MARCH 26th.	LADIES & TOTS SKATING	10:00 am		
	MINOR HOCKEY	4:45 pm	to	6:45 pm
	BROOMBALL			
	WAREHOUSE vs WARLOCKS	7:30 pm		
	ROCKETS vs ROYALS	9:00 pm		
WEDNESDAY MARCH 27th.	MINOR HOCKEY	4:45 pm		
	BRAVES PRACTICE	7:00 pm	to	8:00 pm
	PUBLIC SKATING	8:30 pm	to	10:30 pm

### BROOMBALL

Doubleheader Broomball will be played on Tuesday, Thursday and Friday nights with a single game on Sunday night. The admission will be

ADULTS: 50¢ CHILDREN ACCOMPANIED: 25¢

On Sunday night the admission will be ADULTS: 25¢

There are nine teams in the league and the schedule will run until April 25th.

# SPORTS BEAT

by "DON"

Over 500 people turned up at the arena over the week-end to witness the Juvenile series between Mount Pearl and our local All-Stars. The home town boys won both games. On Saturday night the score was 7 - 6 with Murphy and Martin blinking the red light twice. For the visitors Singleton picked up three goals and one assist. On Sunday afternoon the local boys outlasted the visitors 11 - 8. Paul Newhook scored three times and helped set up three others while for Mount Pearl, Harding found the range four times.

Both games were cleanly played and the teams were evenly matched. The turnout of spectators was encouraging and augers well for future Minor Hockey Games.

This past week-end I had the misfortune to attend and participate in the so-called Newfoundland Provincial Basketball Championship held in the Capital City of St. John's. I say misfortune because never before have I participated in a more ridiculous excuse for sport.

First of all let me congratulate the Fieldians, 1968 Newfoundland and Labrador Basketball Champions. They were by far the superior team and deserved to win. For our own team, we won our first game at 9:15 am: lost the encounter at 11:15 am: then lost again at 2:45 pm: that's a lot of basketball in 6 hours! On their road to victory, the Fieldians played a game on Friday night, opposed us in our second game on Saturday, played another in the afternoon and then the championship game on Sunday. In order for us to win the championship we would have had to play five games on Saturday, which was physically impossible. The Championship game was played at 1:00 pm on Sunday with no games on Sunday morning. To my way of thinking Sunday could have really been utilized so as not to have had so many games on Saturday. Of course Monday was a statutory holiday!!!

Our third game was against Memorial University and we were soundly beaten. As a matter of fact they tried to embarrass us but it backfired. All during the 2nd half the opposition froze the ball, even when they were alone under the basket, they elected to hold rather than shoot. The spectators soon caught on and were disgusted. Basketball has been growing by leaps and bounds during the past 5 years, but from a spectators point of view it was set back another ten during the Labrador City- Memorial game. I think it's better to say no more, except that there is a right way and a wrong way to rest during a game and coach Ed Brown of Memorial certainly chose the wrong one.

On Friday past, 16 ladies teams took to the ice at the curling club to participate in the Annual Ladies Open Bonspiel. The winning rink in the "A" event was skipped by Madelene Banfield on Knob Lake, while the runner up was another Knob lake rink skipped by Raymonde Gagnon. The "B" event was also won by a Schefferville rink skipped by Evelyn Turnbull while Carol's Dallas Cobey was runner up. In the "C" event, Dot Honberge and her rink took first place while Ethel Johnson was runner up. All in all a profitable week-end for Schefferville.

According to all reports the ladies had a wonderful time, but then,

" DON'T YOU ALWAYS AT THE CURLING CLUB? "

THAT'S THIRTY FOR THIS WEEK, AND REMEMBER - " IF YOU CAN'T TAKE  
PART IN SPORT, BE A GOOD ONE ANYWAY "

---

INSURANCE  
 FIRE                      CONTACT                      AUTO  
BOWRINGS INSURANCE  
 (A DIVISION OF BOWRING BROS. LTD.)

MARINE                      MISC

THE MALL - SHOPPING CENTRE  
LABRADOR CITY:

MANAGER: MRS VIRGINIA CAVERLY,  
PHONE: 944 - 5388.

THURSDAY & FRIDAY NIGHT ONLY  
GIGANTIC SAVINGS

LADIES CAPES  
SPECIAL \$14-88

A GROUP OF LADIES  
COTTON DUSTERS  
LIGHT PASTEL  
SHADES

S-M-L \$1-99

A LARGE GROUP  
OF LADIES BULKY  
KNIT SWEATERS  
PULLOVER & CARDIGAN

S M L VALUES TO  
\$1-99 \$15-00

MENS ALL WOOL  
SPORTS JACKETS  
PLAINS  
CHECKS  
TWEEDS

SIZES 34-46  
VALUES TO \$16-99  
\$35-00

BOYS SWEATERS  
CARDIGANS  
VEE NECKS

SIZES 8-16 \$2-00  
REG TO \$4-98

A LIMITED QUANTITY  
OF LADIES & KIDDIES  
WOOLLEN MITTS

VALUES TO 88¢  
\$3-49

SUPER SPECIAL

TABLE LAMPS  
REG \$6-98

\$3-97

*Amre's*  
WABUSH

- T.V. SCHEDULE -

MONDAY THROUGH FRIDAY

4:00 4:30 The Edge of Night  
 4:30 5:00 Bonny Prudden  
 5:00 5:30 Take 30  
 5:30 6:00 Dobino  
 6:00 6:30 La Boite a Surprises

THURSDAY MARCH 21st.

3:30 4:30 Canadian School Telecast  
 6:30 7:00 Upside Town  
 7:00 7:30 Let's Go !  
 7:30 8:00 Green Acres  
 8:00 8:30 Hogan's Heroes  
 8:30 9:00 Telescope  
 9:00 9:30 A la Seconde  
 9:30 10:00 Camera '68  
 10:00 10:30 Don Messer's Jubilee  
 10:30 11:00 Man at the Centre  
 11:00 C.B.C. News

FRIDAY MARCH 22nd.

4:00 4:30 'Rare Ones' and 'Alaska Trail'  
 6:30 7:00 Upside Town  
 7:00 7:30 Let's Go !  
 7:30 8:30 Perdus dans L'espace  
 8:30 9:00 Get Smart  
 9:00 9:30 The Tommy Hunter Show  
 9:30 10:30 ' THE BARON '  
 10:30 11:00 In Person  
 11:00 C.B.C. News  
 11:10 Late Night Theatre -  
 ' CAST A LONG SHADOW ' with  
 Audie Murphy, Terry Moore, John Dehner,  
 and James Best.

SATURDAY MARCH 23rd.

4:00 5:00 Championship Tennis  
 5:00 5:30 Tour de Terre  
 5:30 6:00 Bilule Tarmacadam  
 6:00 7:00 Moby Dick & Bugs Bunny  
 7:00 7:30 The Mark of Zorro  
 7:30 8:00 This Land of Ours  
 8:00 8:30 The Beverly Hill Billies  
 8:30 10:30 N.H.L. Hockey - BOSTON at  
 TORONTO  
 10:30 11:00 Les Couche Tard  
 11:00 11:10 C.B.C. News  
 11:10 Cinema - ' LA CHAINE '  
 avec Tony Curtis et Sidney Poitier.

SUNDAY MARCH 24th.

4:00 4:30 Man Alive  
 4:30 5:00 Hymn Sing  
 5:00 5:30 La Vie Qui Bat  
 5:30 6:00 Les Hommes des L'espace  
 6:00 6:30 Frankenstein Junior  
 6:30 7:30 The Ed Sullivan Show  
 7:30 8:00 Flashback  
 8:00 9:00 Les Beaux Dimanches  
 9:00 10:00 Donanza  
 10:00 The way It Is

MONDAY MARCH 25th.

6:30 7:00 Forest Rangers  
 7:00 7:30 Let's Go !  
 7:30 8:30 Le Paradise Terrestre  
 8:30 9:30 Show of the Week  
 9:30 10:00 Front Page Challenge  
 10:00 11:00 The Carol Burnett Show  
 11:00 C.B.C. News  
 11:10 WINTER OLYMPICS

TUESDAY MARCH 26th

3:30 4:00 Canadian School Telecast  
 6:30 7:00 Upside Town  
 7:00 7:30 Let's Go !  
 7:30 8:30 The Rod Skelton Hour  
 8:30 9:00 Rue de Pignons  
 9:00 9:30 A Guichet Ferme  
 9:30 10:30 WOJECK  
 10:30 11:00 The Public Eye  
 11:00 C.B.C. News  
 11:10 WINTER OLYMPICS

WEDNESDAY MARCH 27th.

6:30 7:00 Upside Town  
 7:00 7:30 Let's Go !  
 7:30 8:00 D'Iberville  
 8:00 8:30 Moi et L'autre  
 8:30 9:30 Mission Impossible  
 9:30 11:00 Festival presents:-  
 ' THE MATADOR '  
 11:00 C.B.C. News.

\*\*\*\*\*  
 ^ THIS SCHEDULE IS SUBJECT ^  
 ^ TO CHANGE ^  
 ^ WITHOUT NOTICE ^  
 \*\*\*\*\*

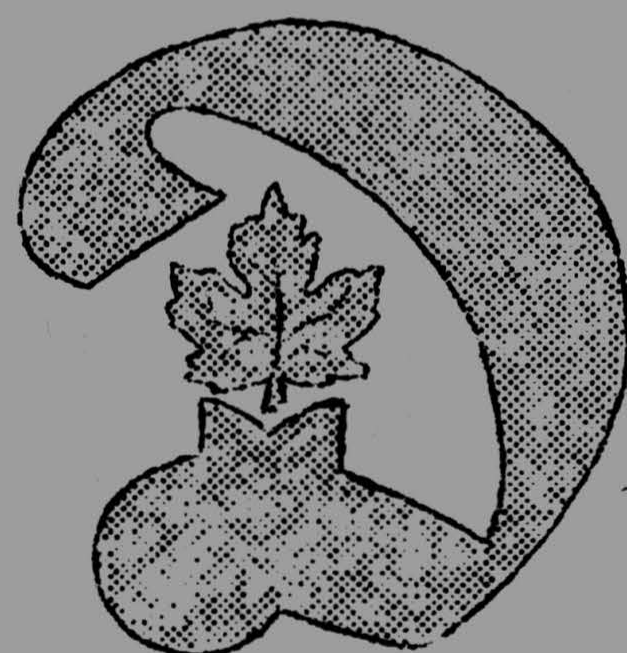

**DOMINION  
STORES**

SHOP AT YOUR FRIENDLY DOMINION STORE

ARRÊTES A VOTRE MAGASIN DOMINION

AND REMEMBER

ET SOUVENEZ VOUS

" IT'S MAINLY BECAUSE OF THE MEAT "

"C'EST SURTOUT A CAUSE DES VIANDES"

FOR FURTHER INFORMATION ON OUR

DES SPECIAUX

SPECIALS

VOYEZ LA BROCHURE QUE SERA

SEE THE BROCHURE WHICH IS BROUGHT

DELIVREE A VOTRE PORTE.

TO YOUR DOOR

LABRADOR CITY

WABUSH

# SPECIALS THIS WEEK

MARCH 21<sup>ST</sup>, 22<sup>ND</sup>, 23<sup>RD</sup>

INSTANT  
MAXWELL HOUSE  
COFFEE 10<sub>oz</sub>

"BONUS PACK" 12<sub>oz</sub>  
\$1-77

"CATELLI"  
CHICKEN NOODLE  
SOUP

2 / 27¢

"CRISCO" VEGETABLE  
OIL  
38<sub>oz</sub> 99¢

"JELLO"  
LEMON PIE FILLING  
12<sub>oz</sub> 47¢

"YOUVILLE"  
STRAWBERRY JAM  
EXTRA SPECIAL  
24<sub>oz</sub> 47¢

"SECRET"  
SPRAY DEODORANT  
5<sub>oz</sub> \$1-09

GOLDEN B.C. APPLES 12 / 99¢

SHALLOTS  
2 / 29¢

N.B. POTATOES  
50 lb. / \$2-59

FROZEN LEG OF LAMB 69¢ lb

"SWIFT" BACON  
83¢ lb

FROZEN CHICKEN  
3 / 4 lb 45¢ lb

CUP & SAUCER Reg. 50¢ SPECIAL 39¢

53 PIECE SET OF DISHES Reg \$35-95.  
LIMITED QUANTITY SPECIAL \$25-95.

BOWRINGS

LABRADOR CITY  
FOR VALUE