

**INTER-CITY  
TRANSPORT  
LIMITED**

BONDED CARRIERS  
MEMBERS N.L.T.A.  
GENERAL TRUCKING



PERMIT - 445  
WAREHOUSING  
BODY - SHOP  
LABRADOR CITY  
Phone 944-2523

# The Aurora

The weekly newspaper of Labrador West

Vol. 1 No. 38

PUBLISHED IN LABRADOR WEST, MONDAY, DECEMBER 22, 1969

Price 10 cents.

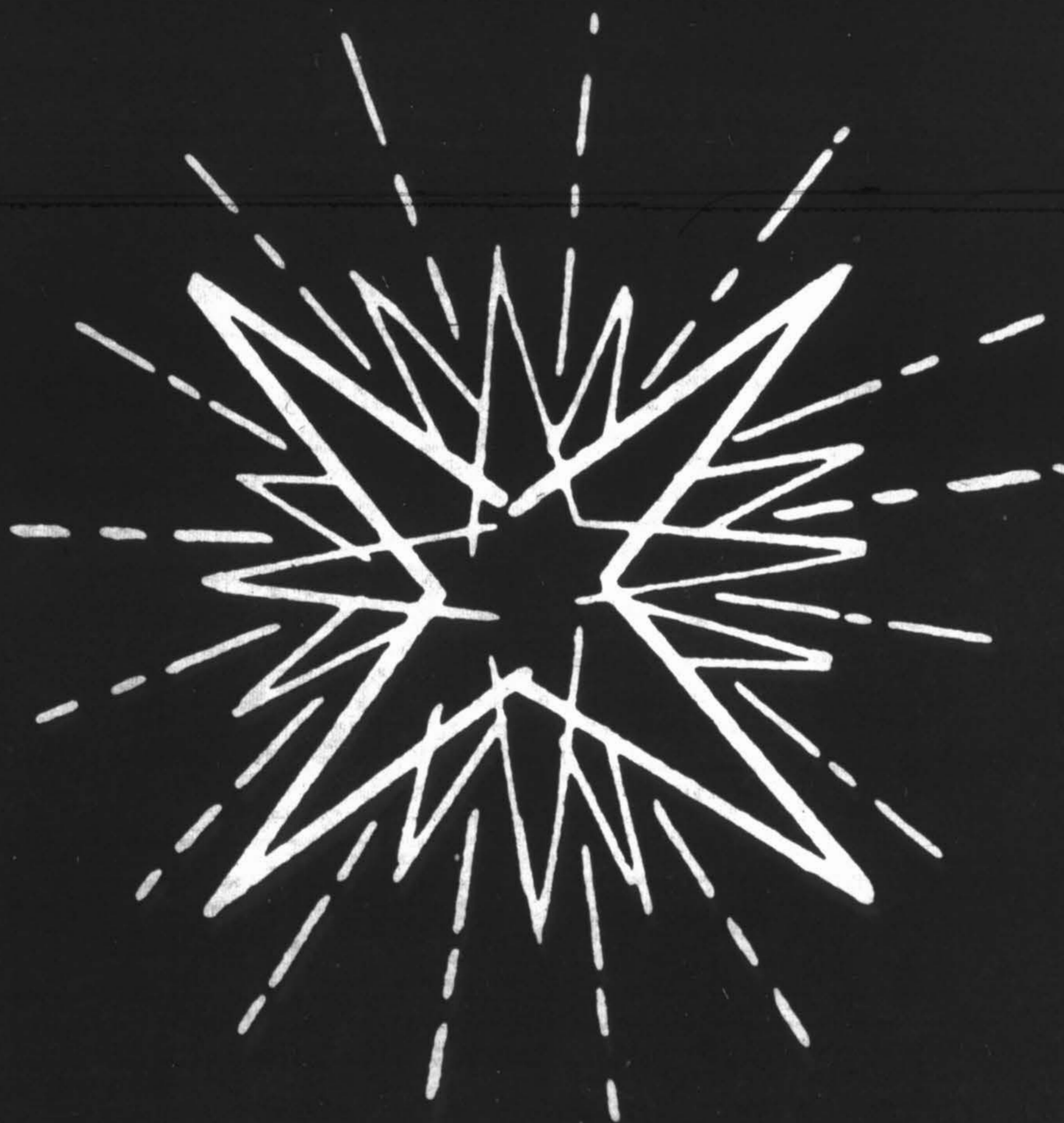

Canada Grade "A" Cryovac-Young-Tender

# DELUXE Golden Bird DINDES TURKEYS

Deluxe Golden Bird  
Canada Catégorie A  
Jeunes-Tendres

**53¢** lb. 20 lb. et plus  
20 lbs. up **47¢** lb.

6 - 18 lb.

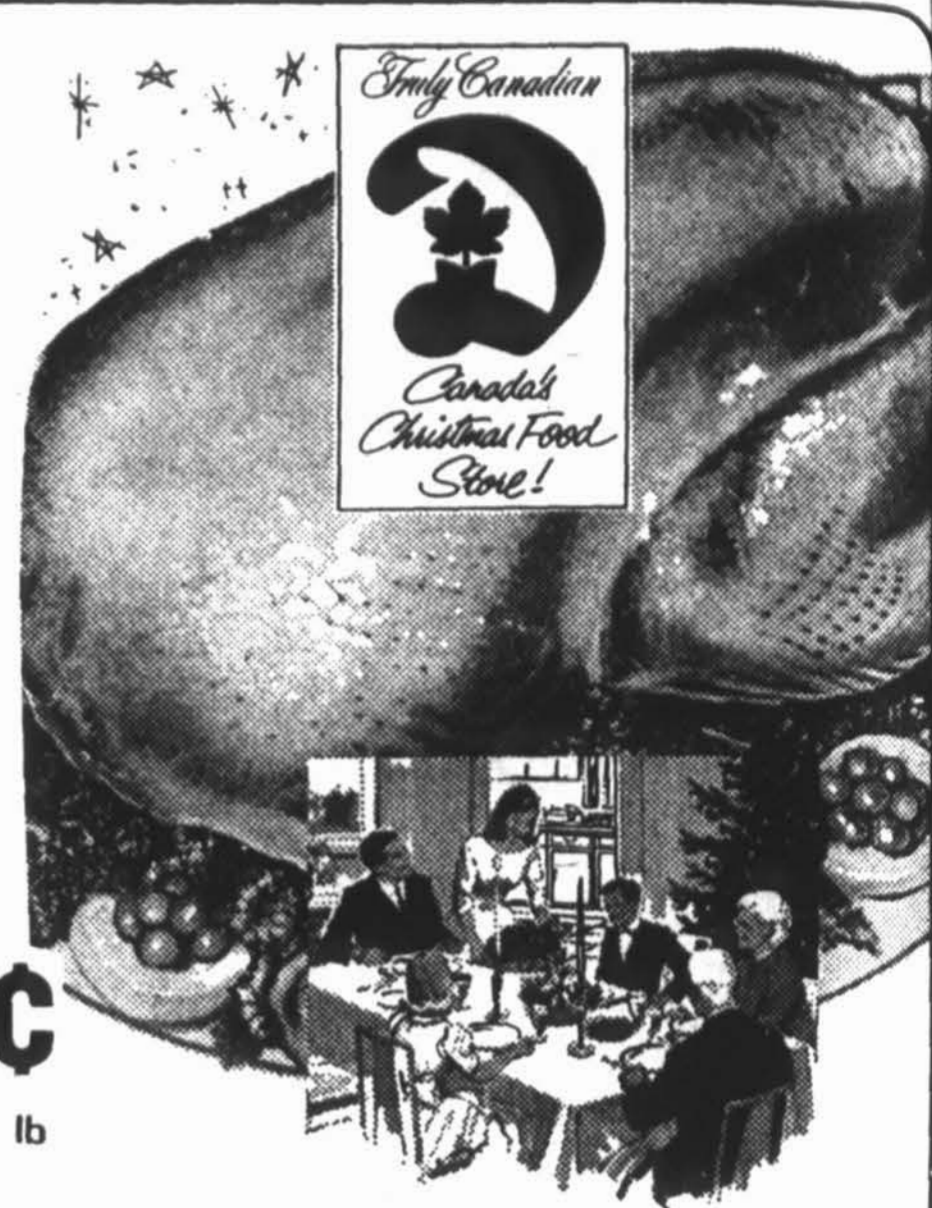

Canada Grade "A" Young Tender Eviscerated

# CRYOVAC TURKEYS DINDES

Cryovac  
Canada Catégorie A  
Jeunes-Tendres

Dindons  
20 lb et Plus  
Young Toms  
20 lbs. up

**43¢** lb Dindes  
6 - 18 lb  
Hen Turkeys **49¢** lb

Maple Leaf-Legrade-Swift-Bone In-Whole or Half

**LEG of HAMS** ready to eat lb.

**89¢**

Ideal for Tourtières!

**Fresh Ground Pork**

lb **79¢**

Jambon dans la Fesse-Maple Leaf-Legrade ou Swift

Porc Frais Haché-Ideal pour Tourtière!

Enjoy an Excellent Festive Meal  
WITH DOMINION OWN BRAND PRODUCTS!

Preparez un Excellent Repas des Fetes  
Avec des Produits de MARQUE EXCLUSIVES a DOMINION!

Domino **Tomato Ketchup** 2 Bout 49¢  
Ketchup aux Tomates Domino 11 oz. Btles

Dominion **FANCY PEAS** 4 Btes 99¢  
Pois de Fantaisie-Dominion 19 oz. Tins

Dominion Fresh (64 oz. Btle 1.09) **ORANGE JUICE** Bout 59¢  
Jus d'orange Frais-Dominion (Bout. 64 oz. 1.09) 32 oz. Btle

Richmello **INSTANT COFFEE** Pot 1.45  
Café Instantané Richmello 10 oz. Jar

Grand Prix (10 oz) Case of 24 **SOFT DRINKS** Tins 3.29  
Liqueurs Douces-Grand Prix en Boîtes 10 oz. Caisse of 24

Richmello 1 lb. - 2 lb. - 3 lb. **FRUIT CAKE** ASSORTED PRICES  
Gâteaux aux Fruits Richmello-Prix Variés.

**RICHMELLO**  
Ice cream 1.05  
1/2 Gal.  
CREME GLACEE  
Richmello

Domino Choice **Tomatoes** 49¢  
2 Btes 19 oz. Tins  
Tomates de Choix  
Domino

Domino **Mixed Nuts** 1.09  
Pqt. 16 oz.  
Noix Mélangées  
Domino

Domino Frozen **SLICED STRAWBERRIES** Pqt. 55¢  
Fraises Tranchees-Congelees Domino 15 oz. Pkg.

Domino Choice **FRUIT COCKTAIL** Bte 55¢  
Cocktail aux Fruits Domino 28 oz. Tin

Dominion **Cookies** Value Pack 99¢  
Biscuits Dominion. 2 1/4 lb.

**Verres à COLA TUMBLERS** 6 45¢

## FRESH FRUIT & VEGETABLES

California U.S. Canada No. 1 Grade-Sweet-Juicy **RED EMPEROR GRAPES** RAISINS ROUGES lb. 39¢  
De Californie E.U. Empereur  
Catégorie No. 1 au Canada

From B.C. Fancy Grade Golden or Red Delicious **APPLES** 29¢ lb  
Pommes Rouges ou Dorés  
De C.B. Surchoix

Florida U.S.-Canada No. 1 Grade Seedless White - 48's **GRAPEFRUIT** 8/99¢  
Pamplemousses Blancs  
De Floride-Gross. 48

California U.S. No. 1 Grade - 48's **CELERY** 33¢ Ch. ea.  
Celeri de Californie  
E.U. Grosseur 48

EVERYTHING GUARANTEED!  
We reserve the right to limit Quantities!  
DOMINION STORES LIMITED

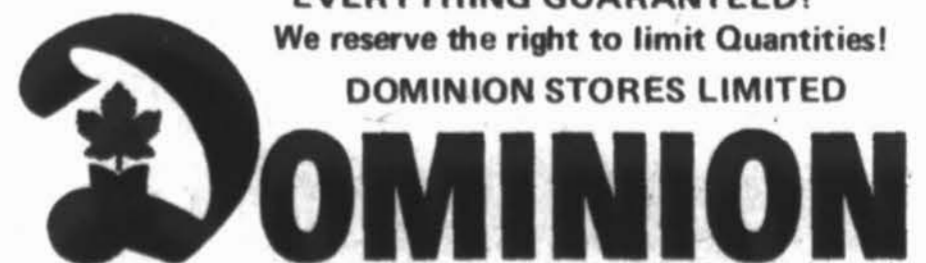

**CENTRE D'ACHATS CAROL LAKE  
SHOPPING CENTRE LABRADOR CITY  
WABUSH PLAZA, LABRADOR**

**FREE! 12 GREAT ART MASTERPIECES**  
**FREE! One new picture each week for 12 weeks**  
**GRATIS ! 12 Magnifiques REPRODUCTIONS**

GRATIS! Une Nouvelle Gravure chaque Semaine pour 12 Semaines

Save on the purchase of Beautiful Frames.  
**VALUABLE COUPON**  
Redeemable at Dominion-Limit one per customer  
**ONE FREE PRINT**  
with purchase of \$5.00 or more (Except on Cigarettes)  
Valid Week Ending December 20-27 & January 3  
Echangeable au Dominion-Limite une Offre par Client  
**GRATIS! UNE REPRODUCTION**  
Avec achat de \$5.00 ou Plus (Sauf sur les Cigarettes)  
Valide Semaine du 20-27 Dec. et 3 Jan.  
Coupon de Valeur  
**ONE ART PRINT FREE**

Epargnez sur Achat de Jolis Cadres

# News briefs

Reliable sources have indicated that Charles S. Devine former member of the House of Assembly for Labrador West will shortly announce his candidacy for the Leadership of the provincial Progressive Conservative Party. A convention to decide who will be the new leader will be held in St. John's early in the New Year.

At press time Mr. Devine would neither confirm or deny this report.

Appearing before Magistrate Rowe last week a resident of Labrador City pleaded guilty to a charge of impaired driving, and was fined seventy-five dollars and his licence suspended for six months.

A resident of Wabush appeared on a charge of having liquor in his possession not obtained in accordance with the Liquor Act, he pleaded guilty and was fined \$20.00.

Another resident of Wabush was convicted under the dog act, and paid the \$10.00 fine for allowing his dog to roam at large.

Magistrate Rowe visited Churchill Falls recently, and a male resident appeared, charged with theft of an amount over \$50.00, he was convicted given a sentence of 1 day in jail and fined \$150.00.

Two other residents of Churchill were charged under the Wildlife Act, one for not having a valid hunting licence, and the other for carrying a loaded firearm in a vehicle, both were convicted and fined \$25.00.



**RECORD SCORER** - For the second time in as many weeks, a Wabush resident, Mrs. Peggy Barnes, has chalked up a record score of 180, in the mixed darts league. Mrs. Barnes follows Mrs. Hoben who as far as can be ascertained was the first lady in the area to come up with such a score in regular league games (Aurora Photo).

## Social calendar

### WEDNESDAY, DEC. 24th

Ashuanipi Social Club - Lounge and Tavern closes at 6 p.m.  
Royal Theatre - Eye of the Cat.

O'Brien Hall - Closed at 6 p.m.

Sir Wilfred Grenfell Hotel - Lounge and Tavern closes at 6 p.m.

Legion (Wabush) - Closed at 6:30 p.m.

### THURSDAY, DEC. 25th

Ashuanipi Social Club - Closed all day.

Royal Theatre - Camelot, winner of 3 Academy Awards.

O'Brien Hall - Closed all Day.

Sir Wilfred Grenfell Hotel - Lounge and Tavern closed all day.

Legion (Wabush) - Closed all day.

### FRIDAY, DEC. 26th

Ashuanipi Social Club - Dart's Dance, music by the Krystals, admission by ticket only.

Royal Theatre - Camelot

O'Brien Hall - Nurses association dance.

Sir Wilfred Grenfell Hotel -

Lounge opens at 5 p.m. Tavern at 2 p.m.

Legion, Wabush - Dance at 9 p.m.

### SATURDAY, DEC. 27th.

Ashuanipi Social Club - Dancing to the music of the Krystals at 9 p.m.

Royal Theatre - Never A Dull Moment with Dick Van Dyke and Edward G. Robinson.

O'Brien Hall - Chamber of Commerce, Car Draw.

Legion, Wabush - Dance at 9 p.m.

Sir Wilfred Grenfell Hotel - Dancing commencing at 9 p.m.

### SUNDAY, DEC. 28th.

Ashuanipi Social Club - Lounge closes at 6 p.m., tavern at 7 p.m.

Royal Theatre - Elvis Presley in Live a Little, Love a Little.

O'Brien Hall - Games night & Ski-doo Raffle.

Sir Wilfred Grenfell Hotel - Dancing at 9 p.m.

Legion, Wabush - Dance commencing at 8:30 p.m. music by the Arcades.

### MONDAY, DEC. 29th.

Ashuanipi Social Club - Movie night at 9 p.m.

Royal Theatre - Live a little, Love a Little.

Sir Wilfred Grenfell Hotel - Movie night, at 9 p.m.

Legion, Wabush. Pre-New Year's Eve Dance, with the

Arcades.

### TUESDAY, DEC. 30th

Ashuanipi Social Club - Movie night at 9 p.m.

Royal Theatre - The Bliss of Mrs. Blossom.

O'Brien Hall - Dancing at the Music of the Checkmates.

Sir Wilfred Grenfell Hotel - Movie night at 9 p.m.

## Moderator visits

Dr. R. McLure whose radiant personality is known beyond religious circles, since he is the first layman to hold the position of the United Church Moderator, visited Labrador City, and the Congregation, held a social evening on Thursday night, December 11th.

After a pot supper where many delicatessens were served by the different ladies, Dr. McLure after thanking the "hostesses" spoke about his return from China where he spent thirteen years as a Medical Doctor and a Surgeon treating leprosy in different centres in China.

He stressed the point of the alarming increase of the populations on the Asiatic Continent, and the overpowering

number of the yellow populations who slowly realize with bitterness all the privileges that the white man has been enjoying so far in the Occidental world.

Enlarging the subject of Fellowship and Brotherhood that our religion should mean, he reminded us of the mystic spirit of the old civilizations and philosophy of the Chinese and generally speaking of the Oriental old religions, he pointed out that forgiveness for example is not an occidental privilege, but is meant and practised among non Christian human beings who grasped the meaning of God.

A most enjoyable and enlightening talk, which left each one of us full of enthusiasm, and Christmas spirit.

### ROY BESSETTE

**PAINTING CONTRACTOR**

**DOMESTIC AND**

**INDUSTRIAL PAINTING**

REASONABLE

PRICES

5 MAPLE

CRESCENT

APARTMENTS

PHONE 944-5551



PHONE TODAY FOR FREE ESTIMATE

PHONE 944-5551

Call 944-2226 or 944-5323

FOR ALL YOUR DRY CLEANING AND LAUNDRY

**Daily Pick-Up And Delivery**

**CAROL LAUNDRY & DRY CLEANERS**

PHONE 944-2226 or 944-5323

# The Aurora

Published every Wednesday at Labrador West, Newfoundland and Labrador and printed by Robinson-Blackmore Printing and Publishing Limited, O'Leary Avenue, St. John's, Newfoundland. Subscription rate Canada and Foreign \$6.50. Mailing address, P.O. Box 2090, Labrador City.

## Guilt and Christmas

Many people enjoy torturing themselves and others as well. They love to remind themselves of unfortunate things while they are having a good time in the midst of plenty. This is true especially at this time of year.

Christmas should not be a time for searching one's soul to discover, in effect, if there isn't some small way we can make ourselves feel just a little miserable. Christmas is a time of rejoicing and not a time to drag out transitory and usually artificial sentiments about unfortunate people in other places.

All year long we hear about Biafra, Vietnam, China, India and all those places where people are either hungry or at war. There is not one sane person who would not stop, if he could, all the warring and hunger in the world.

It is often said that we do not think enough about unfortunates in other parts of the world but this is not true. In Newfoundland we give thousands of dollars annually to worthy causes. We donate to funds which will alleviate hunger and spread religious and secular education.

We do our part.

It has been said that we do not really feel for the small, starving mites whose pictures face us on television and in printed media all the time.

Who cannot feel some measure of pity for the small, dark children with bloated tummies and bone-thin legs?

It is not fair on us to say we don't extend enough pity for on the other hand, it isn't easy to feel complete compassion for a picture - for someone whom we have never seen in the flesh. If we sent no money at all to destitute people, that would be a different story. Then it would be just to look with a censoring eye on the wealthy, over-fed countries of the world.

There will always be hunger, disease and war. Understanding this, we should not allow ourselves to become maudlin. While major problems will never cease, they can get worse and it is by being concerned and generous that we are doing our part to see they do not get worse.

If we are becoming somewhat too self-critical it is because we are ashamed of having so much of the world's largess.

But Christmas is a time of rejoicing. So rejoice. Appreciate the good things you have!



## Here 'n' there

**SUGGEST INCREASING TAXES ON BEER:** The Association of Canadian Distillers' submission to a Quebec commission on the liquor trade recently contained one similarity to the recent report of the Ontario Addiction Research Foundation. The two groups have one major recommendation in common, although their broad aims differ markedly. They would like all types of beverage alcohol (beer, wine and spirits) to be taxed in the same way, by the proportion of absolute alcohol they contain.

They agree that the present systems of taxation, which are heaviest on spirits and leave beer virtually unscathed, merely shift consumption to cheaper drinks. The foundation argued that all alcohol should be taxed more heavily to reduce total alcohol consumption. The distillers say the tax burden should be spread more evenly, in effect freeing drinkers to choose their "poison" solely on preference. The distillers would like to see wine and spirit prices hold the line until beer catches up, while the foundation wants all prices DOUBLED.

Either way, beer would cost more. The distillers' figures show that a 12 ounce bottle of beer contains 0.546 ounces of absolute alcohol, only slightly less than the 0.604 ounces in a one - and - a - quarter ounce glass of liquor. They recommend price and tax increases on beer totalling 6c a bottle or \$1.45 a case. The proposals are part of a four volume submission to the Quebec government, most of which urges rationalizing liquor services with a thorough overhaul of the existing liquor board administration and policies.

**TOYLAND AND THE CREDIT SQUEEZE:** The credit squeeze made itself felt as toy sales reached their Christmas peak in Canada. The industry expects sales this year to rise by only 5%, compared with the 10% increase in 1968, when they reached \$200 million.

Christmas comes early for the toy makers. The big orders are placed in the summer. The post-Christmas hang-over is less severe today than it was a few years ago. Toy makers used to spend January filling out credit slips for stores returning unsold goods. More careful market research had reduced this burden, and intensive marketing aimed at the birthday market and other occasions has helped to spread production throughout the year.

Exports are also slower this year. Shipments to the U.S., Britain and Australia rose from \$3.2 million in 1967 to \$4.4 million in 1968. This year has been difficult for exporters. Toy manufacturers cite three

drawbacks: (a) the lack of a real breakthrough into the U.S. market, (b) tougher domestic competition in Australia (c) higher duty and British sales tax costs.

**UNEMPLOYMENT IN NEWFOUNDLAND:** The unemployment picture in Newfoundland is darker than in any other province and is getting worse, according to a survey conducted by the Dominion Bureau of Statistics. "Consistently, Newfoundland leads the list, and lately Newfoundland is gaining on other provinces," says a DBS spokesman. Recent figures show 7.4% of the work force unemployed (11,000 out of 149,000). The spokesman said that this is nearly double the rate in Nova Scotia during the same period, when

unemployment there, on the basis of similar statistics was 3.9%.

**SECURITY IS A SLOW DRIVER:** Dr. Leslie Morrish, a British psychiatrist, reports that the man who drives fast and aggressively may be trying to compensate for a sense of sexual insecurity. The doctor's finding is part of a program of research into driver safety sponsored by British Leyland Motors, makers of Jaguar cars (120 miles an hour). Dr. Morrish admits more research is needed in the field. His findings do not necessarily mean that the slower the driver the more secure he is. The safety record of parked cars is something else again.



It's time to greet our many friends and wish them the best!

**THE MANAGEMENT AND STAFF OF THE SIR WILFRED GRENFELL HOTEL**

## The new law on drinking and driving

The new law on drinking and driving states that: If you are in charge of a motor vehicle while you have more than .08 grams of alcohol per 100 millilitres of blood, you are committing a criminal offence.

The Alcohol is measured by a breathalyzer, a simple reliable instrument. You breathe into a tube, the device indicates whether your blood stream has an alcohol content of more than point zero eight.

Any police officer, anywhere in Canada has the right on reasonable grounds, to require you to take the breathalyzer test if you are in control of a motor vehicle.

If the breathalyzer indicates more than .08 percent alcohol, you are guilty of a criminal offence and liable on conviction to a fine or imprisonment or both.

Refusal to take the test is also a criminal offence, and makes you liable to the same penalties as if you had failed the test.

Traffic accidents killed 5,254 Canadians in 1968. At least 50% of these involved alcohol.

Nobody knows exactly how much an individual can drink before reaching .08. The quantity may vary from day to day, even hour to hour. It depends on what you've had to eat, your size, whether you are tired and so many other factors.

A second drink may be too much. A few drinks can make you feel confident, sure of yourself, certain that you can control a car. Is this really true? The law is designed to save lives, perhaps your own.

## mind teasers

A circular plot of ground with a circumference of 176 feet is surrounded by a walk with a circumference of 308 feet. What is the width of this walk?

ANSWER

21 feet. Divide 176 by 22/7 (pi) by 2; divide 308 by 22/7 by 2; subtract first result from the second result.

If 3-inch squares are to be cut from each corner of a square sheet of aluminum, and a box constructed by bending up the sides and if the volume of the finished box is to be 192 cubic inches, what are the dimensions of the original sheet of aluminum?

ANSWER

14 inches square. Divide 192 by 3; extract square root of this result; to this add the sum of 3 and 3.

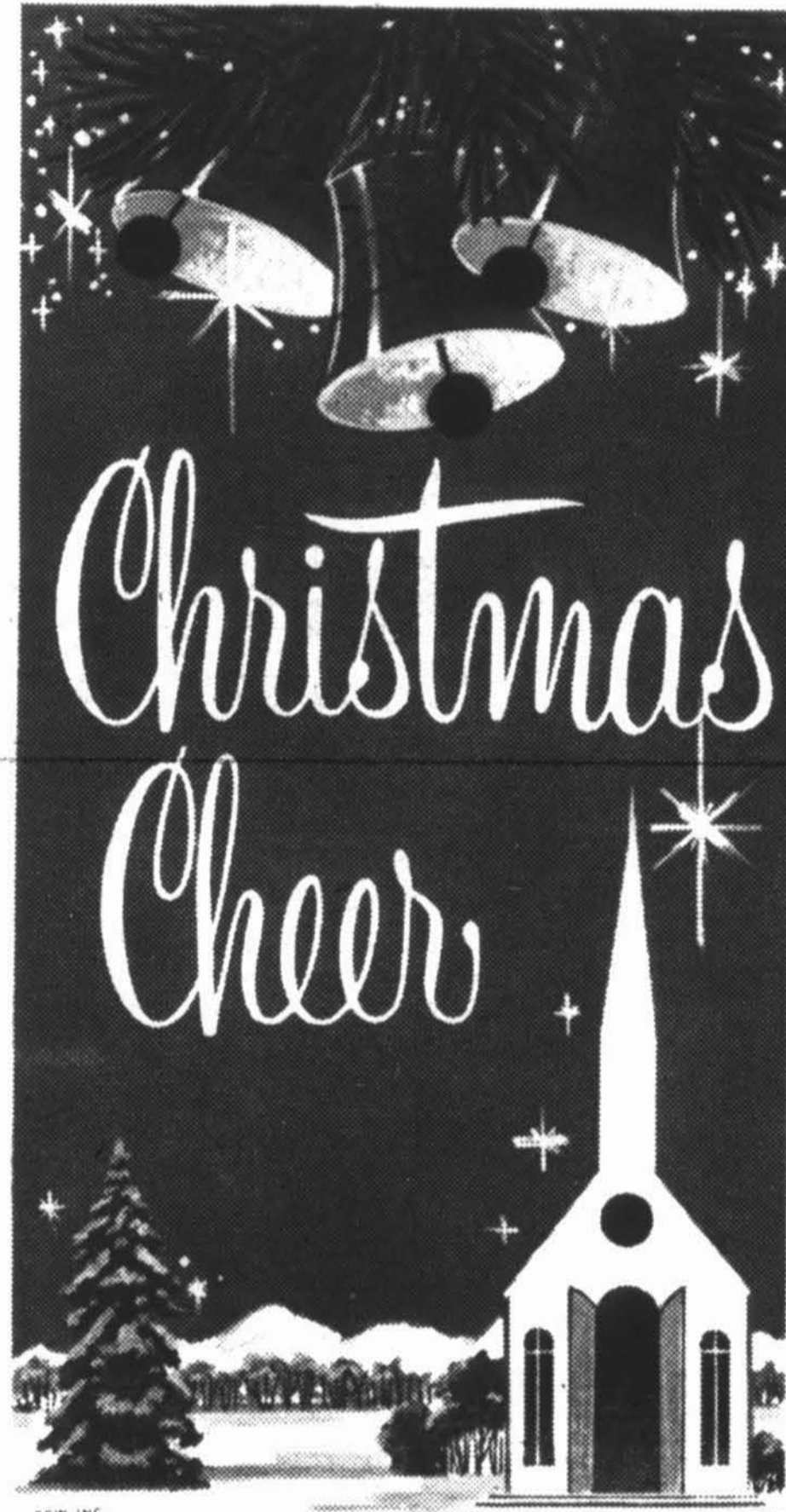

It's always a pleasure to greet friends at this holiday season and wish them the best: health, wealth, and happiness!

**BOARD OF DIRECTORS,  
MANAGEMENT AND STAFF  
THE ASHUANIPI  
SOCIAL CLUB  
LABRADOR CITY**

### MARITIME LIFE ASSURANCE COMPANY

HEAD OFFICE HALIFAX

The Company with "Venture Growth"-  
the modern concept of life protection.

Resident agents in Labrador City,  
Clive Gilbert, Phil Lozman phone 944-2294  
Non-resident agent, Mike Power.  
Branch Office Millbrook Shopping Centre,  
Corner Brook, Nfld.  
Branch Manager M.W. Scott, Master Mariner.

## TIME WAS...

**when leeches  
were used to  
cure illness**

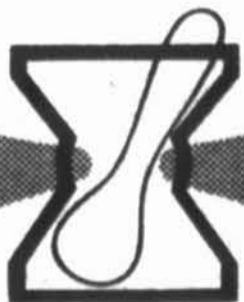

You'll agree that modern  
drugs are a vast improvement  
on ancient methods! We're  
proud to be part of the  
**CITY DRUGS LTD.**

SHOPPING CENTER - LABRADOR CITY  
**TELEPHONE 944-2448 or 5395**

## Quotes

A man's good breeding is the best security against another's bad manners - (Lord Chesterfield).

Forgiveness ought to be like a cancelled note torn in two, and burned up, so that it never can be shown against one. - (Henry Ward Bucher).

The memory and conscience never did and never will agree about forgiving injuries.



As you and loved ones  
gather around the Christmas  
tree, we hope joy reigns supreme!

**FROM THE MANAGEMENT AND STAFF  
OF  
CITY MOTORS (LABRADOR) LIMITED  
LABRADOR CITY                      PHONE 944-2617**

## The lighter side

**OXFORD STUDENTS:** The Warden and Fellows of Wadham College, Oxford, in a letter to a group of students who had presented a list of non-negotiable demands:

Dear Gentlemen: We note your threat to take what you call "direct action" unless your demands are immediately met. We feel that it is only sporting to let you know that our governing body includes three experts in chemical warfare, two ex-commandos skilled with dynamite and torturing prisoners, four qualified marksmen in both small arms and rifles, two ex-artillerymen, one holder of the Victoria Cross, four karate experts, and a chaplain. The governing body has authorized me to tell you that we look forward with confidence to what you call a "confrontation", and I may say even with anticipation.

**WEAKENED HOSTESS:**

Gone are my parents and in-laws  
At home is each nephew and niece;  
Each room is silent; each door is locked;  
And at last I have relative peace.

**MOTHERS BOY:** Chairman introducing guest speaker: "I quote from a letter: 'John is the greatest president the bank has had. His qualifications and accomplishments defy description. Not only is he the most efficient, most intelligent and most successful banker, he is also the most handsome.

The stunned silence was broken when the chairman added: "The letter is signed - Mother."

**CASH QUERY:** If money doesn't grow on trees, why do banks have branches?

**TRAFFIC HAZARD:** From a St. John's paper: A new motel is to be built at Fortune. Work has commenced on the new building which will contain 16 rooms and SEVERAL UNITS ON THE MAIN HIGHWAY. The building will also contain a modern restaurant and club. The motel is being erected by Walter Hefferton of St. John's.

**CLOTHES NO:**

In fashion when told I must get up-to-date, I negate.  
If they ask me to sample a turtleneck sweater,  
I don't do it better,  
If they ask me to wear beads or a necklace of gold, I grow cold.  
And when they say on tunics like Nehru or Mao,  
I say, "Nao!"

**EVEN STEPHEN:** A father asked his son if he had time to shovel a path before going out on his date.

"Sure buster," replied the boy airily.

"That's no way to address your father! Come on, let's have it properly.

Do you have time to shovel the path?"

"I'm afraid not, Sir," answered the boy.

**BEACH NOTE:** What with bathing suits growing skimpier and skimpier, men feel that bathing beauties are worth wading for.

**THE NEW TEACHERS:** Noting the burden of education costs the New York State Taxpayer's Association asks the State University System to dock the pay of any instructor who cancels classes to take part in a demonstration.

**ESSENCE OF OBSOLESCENCE:**

The advertisers tell me that  
My last year's car is now old hat,  
And that my detergent just can't clean  
It lacks those crystals, blue or green.  
My TV set's no up-to-dater,  
Nor is my refrigerator.  
My stove, to judge by ad men's pages,  
Is something from the Middle Ages.  
Now, seeing that my home's replete  
With items that are obsolete,  
I've started wondering if it's true  
That maybe I'm outmoded too.

### WARTS

**AN HERBAL REMEDY**

Unsightly WARTS on hands, face, feet, permanently removed with 3 to 5 weeks with DEIGHTON'S WART REMOVER. Not an acid, harmless to healthy skin.

**NORTHERN DRUG STORE  
and  
CITY DRUGS LIMITED.**

Reduce the easy SLENDOR  
REDUCING PLAN WAY.

Eat three satisty  
meals a day.  
\$2.50 and \$6.00 sizes.

At **NORTHERN DRUG STORE**  
and **CITY DRUGS LTD.**

# Here 'n' there

**CHURCHILL FALLS:** Churchill Falls (Labrador) Corp. Ltd. has awarded \$10 million in new contracts and orders for its main hydro-electric development. The largest contract for \$5.6 million went jointly to Dominion Bridge Co., Ltd. and Davie Shipbuilding Ltd., a subsidiary of Canada Steamship Lines Ltd. They will supply vertical gates, guides and hoists for a number of water control structures for the Labrador development. Davie's share of the contract will be \$2.2 million and Dominion Bridge will receive \$3.4 million.

Other awards were \$1.7 million to Cegelec Industries

Inc., Laprairie, Que., for porcelain insulators, \$1.4 million to Canada Wire & Cable Co., Toronto, for cables, and \$850,000.00 to Collins Radio Co., of Canada, Toronto, for a communications system.

**AUSTRALIA'S GROWTH UP:** Though Australia's economic situation is often compared to that of Canada, many present trends in Australia appear to point in the opposite direction, judging from the recently published annual report of the Reserve Bank of Australia, covering the 1968-69 fiscal year.

Real Gross National Product

growth accelerated to 8% industrial production increase nearly doubled to 7%, while unemployment dropped to less than 1% of the labor force and consumer prices rose only 2.9%, DESPITE A 6.3% IN WAGES. Exports, which had stagnated the previous year, went up 9%, while import growth was reduced to 1% from 11% the year before.

For 1969 - 70, Australians expect a 9% real increase in GNP and another good export year, especially because of mineral sales. Australia's second nickle mine went into production this autumn and new copper and nickel discoveries are being reported.

## Church calendar

**ST. PAUL'S ANGLICAN CHURCH, LABRADOR CITY**

Rev. W.J. Bellamy.

**WEDNESDAY, DECEMBER 24**

11:30 p.m. - Midnight Eucharist

Christmas Day - 7 a.m. - Holy Communion.

December 26th - 9:30 a.m. - Holy Communion.

Sunday - December 28th, Morning Prayer - 10:30 a.m.

**ST. PETER'S ANGLICAN CHURCH, WABUSH**

REVEREND W.J. BELLAMY

Christmas Day - 9 a.m. - Holy Communion.

December 27th - 9:30 a.m. - Holy Communion.

Sunday, December 28th - 7:15 p.m. Evening Prayer

**OUR LADY OF THE ASSUMPTION**

REVEREND Fr. J. BLOUIN, O.M.I.

Christmas Eve - Midnight Mass.

Christmas Day - Mass at 10 a.m.; Mass at 7 p.m.

Sunday, December 28th - 10 a.m. Mass; 7:00 p.m. Mass.

Weekdays except Friday - Mass at 5:00 p.m.

**PENTECOSTAL CHURCH GLAD TIDINGS TABERNACLE**

PASTOR B.H. HARTWELL

Christmas Day - 7:30 p.m. - Christmas Night

Service.

There will be no Young people's Service for this week.

Sunday, December 28 - 11 a.m. - Morning Worship.

3 p.m. - Sunday School

7:30 p.m. - Evangelistic Service.

**OUR LADY OF PERPETUAL HELP**

Rev. J. Laperriere, O.M.I. and Rev. F. Lemire

Christmas Eve - Midnight Mass.

Confessions before Mass.

Christmas Day - 9 a.m. - Mass; 5 p.m. Mass (French); 11 a.m. Mass; 7 p.m. Mass.

**NOTE:** Listings for the other churches were not available in time for our deadline.



## WATCH FOR OUR

### BUSINESSMEN'S LUNCHEONS From \$1.95

AVAILABLE DAILY 12 NOON to 2 P.M.

**SIR WILFRED GRENFELL HOTEL**

PHONE 282-3221 - WABUSH

# Season's Greetings



*We're decking the halls*

*with holly 'n' mistletoe*

*And sending best wishes*

*to all the folks we know!*

**HANDY ANDY**

(Twin Cities Hardware Ltd.)

Shopping Center - Labrador City

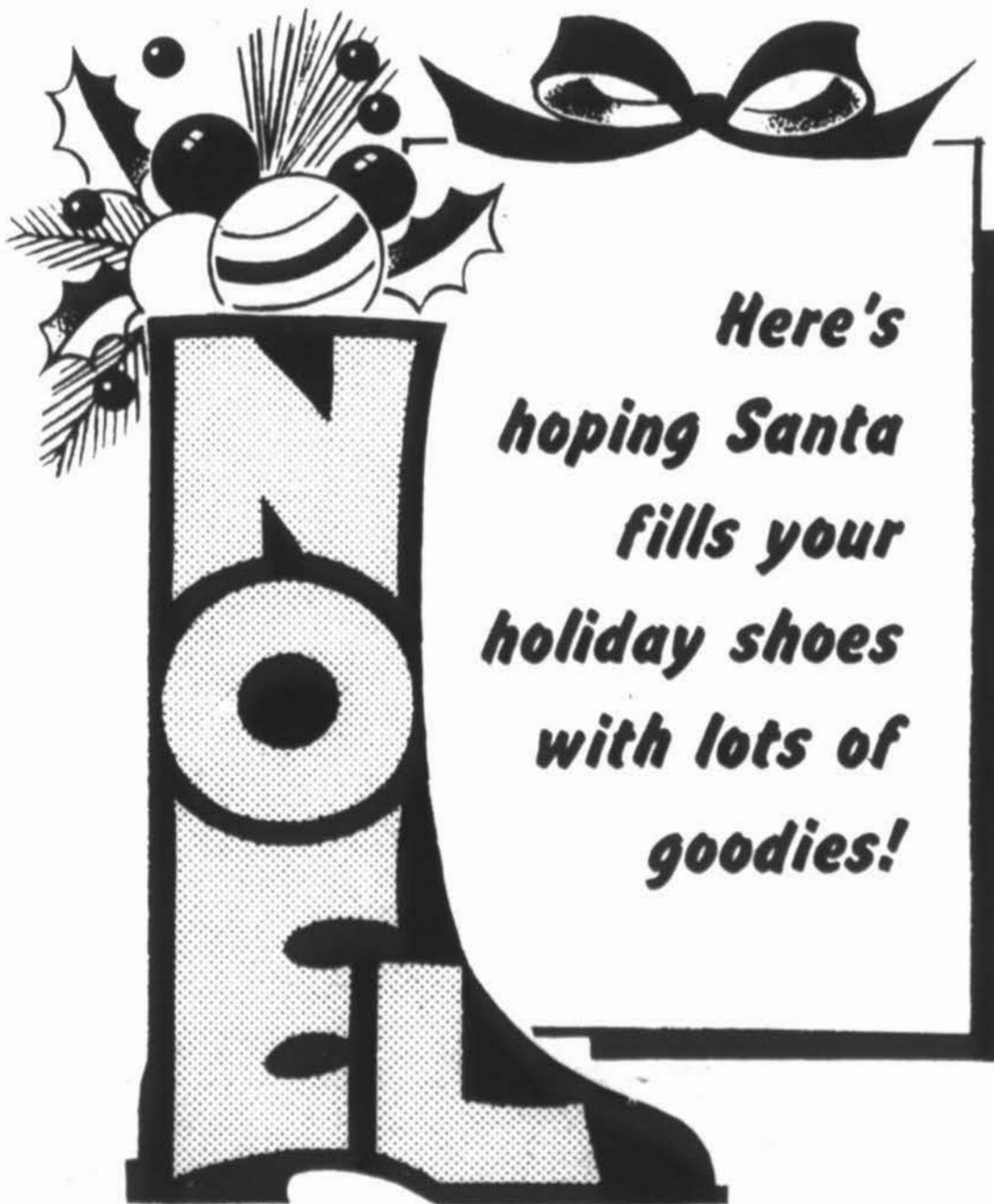

*Here's hoping Santa fills your holiday shoes with lots of goodies!*

**THE SHOE STORE**

Shopping Center - Labrador City

# Scanning the market

BY C.S. DEVINE

**HERE COMES 1970: MOST ECONOMISTS DOUBT RECESSION, FEAR INFLATION.** From Wall St. U.S.A. here are some comments. Gross national product will climb slightly more than 5% from this year's projected total of some \$930 billion. Mr. T.V. D'Allessandro an economist for General Foods Corp., provides a typical comment: "GNP will continue to rise next year, and I don't expect a recession, even a mini-recession." After stripping away increases due to higher price tags, however, Gross National Product will rise hardly at all in the next year, Mr. D'Allessandro and many other economists forecast. During the first half of 1970 and possibly beyond, "real" GNP will probably be "flat," the General Foods analysts says. Many economists define a recession as a period in which real GNP declines for two consecutive quarters, GNP, of course, is the widest statistical measure of general economic activity.

Industrial production will barely increase in 1970. This particular economic index measures the physical output of goods and therefore isn't inflated by price boosts, as is GNP. Also, industrial production naturally doesn't include services, and most analysts expect service industries to expand relatively rapidly in the

next year. A representative forecast of 1970 factory output was recently made by the National Association of Business Economists. The group expects the index to average 174.6 next year. This would be only about 1% higher than the projected 1969 level. The NABE anticipates "a very small dip" in industrial production during the first half of 1970, followed by "a modest pickup during the second half."

Unemployment will rise slightly in the next year. W.H. Gassett, economist for Eaton & Howard Inc., a Boston investment concern, predicts that the jobless rate will climb to about 4.3% of the labour force before mid-1970 and then will "stay around there." This would be nearly a full percentage point higher than the U.S., 3.4% - 3.5% rates that have recently prevailed. But it would still be less than the jobless rate in 1965. It would be far below levels in the early 1960's, when consumer prices were rising at annual rates of less than 2%.

Corporate profits will probably decline in 1970, squeezed between sharp wage increases and sluggish demand. In one typical appraisal, N. Robertson, economist for Mellon National Bank & Trust Co., estimates that pretax profits in the second quarter of 1970 will be some 12% below the year earlier level. There after Mr. Robertson

foresees "only a minor recovery in the second half."

Interest rates will remain close to present high levels but may come down slightly. Much depends, of course, on the progress in stemming inflation. Among those who anticipate "continuing high interest rates" in 1970 is W.H. Chartener, economist for Goldman, Sachs & Co., the large New York investment firm. Looking ahead, Mr. Chartener sees "no recession anywhere here" and accordingly does not expect any major drop in interest rates or the rate of price inflation.

Few analysts are bold enough to peer beyond 1970. Among those who have done so, however, some seem hopeful that inflation will continue to abate in 1971 and later years, while others seem less hopeful. One pessimist, an economist for a major steel producer, fears that prices "will be off and running again in 1971," after a very modest slowing of inflation in 1970. A similar appraisal comes from J.W. Knowles, director of research for the Joint Economic Committee of Congress. The most probable pattern, he recently told a meeting of business analysts, is for some slowing of inflation in 1970 and "then the economy will take off again in the direction of inflationary excesses." He cited the prospect of continuing heavy Federal spending and "public demand" for tax cuts in such a forecast.

**MERRY CHRISTMAS  
AND  
A HAPPY NEW YEAR  
TO ALL OUR FRIENDS  
IN LABRADOR WEST**

**FROM**

**EASTERN  
PROVINCIAL  
AIRWAYS**



**"THE FRIENDLY AIRLINE"**

# A blaze of light ... not ablaze!

Prince Albert, husband of Queen Victoria, is credited with introducing the Christmas tree to England at the time Charles Dickens wrote his classic story "A Christmas Carol". Since then it has become more popular year after year, with decorations becoming more elaborate and more colorful; but electric lighting, while colourful, can pose serious hazards — particularly fire. Follow this advice for a happy and a safe Christmas.

Look for the CSA certification mark when you buy your Christmas lights. It means approval by the Canadian Standards Association.

The ideal Christmas tree light set of the conventional kind should have these characteristics: it should be light in weight; sockets should be strong enough not to break or crack if stepped on; they should have means for secure fastening to the tree branches (usually a metal or plastic clip). To reduce tangling and to improve

appearance, parallel-wired sets should have their cords enclosed in a single covering.

Check lights and wiring thoroughly before hanging them. Discard defective lights, and any wiring that is frayed or bare. Be sure the fuse on the electrical circuit you use is not over 15 amperes.

Carefully follow all instructions provided by manufacturers. The safety features built into equipment can be nullified by careless or improper installations and use.

Do not use electrical equipment on metal trees. A power leak could burn or kill anyone who touches the tree. Use off-tree flood or spotlighting instead.

When setting up a natural evergreen tree, saw off the trunk diagonally at least one inch above the original cut; place the base of the tree in a deep pan of water for the entire period of time it is indoors, and be sure to add water each day to keep the

water level above the cut.

Support the tree in a solid stand so it will not accidentally fall over.

Christmas trees should not be placed near grounding surfaces such as water pipes, or heat-radiating devices such as radiators and heaters.

Choose flameproof or fire retardant decorations.

Plan for a fire emergency. Have alternative escape routes out of the room. Do not place a tree near an exit.

If you do have a natural evergreen, remove it as soon as it shows signs of drying out. Dried out trees are like tinder.

### NOT TO BE TAKEN LIGHTLY

Don't let bulbs touch the tree.

Don't leave the lights on when you go out of the room.

Don't overload the wall plug or extension cord.

Don't use metal icicles near lighting sets.

Don't put the Christmas tree near a fireplace or a TV set.

Don't let small children play near the tree unsupervised, and keep matches, lighters and candles out of their reach.

Be careful with cigarettes. Trees and Christmas wrappings are a fire hazard.

Don't allow piles of Christmas wrappings to accumulate in the house; and don't burn them in the fireplace.

Don't combine polystyrene (a glossy, plastic-like, molded material) candle holders with wax candles in any decoration.

Don't block exits from the house.

### ILLUMINATING YOUR HOUSE

For outdoor decorations, buy decorative lights and equipment which have been tested and approved by the Canadian Standards Association and identified by the CSA label for outdoor use. Outdoor lights have weatherproof sockets and

heavier wiring than required indoors.

For outdoor lighting, parallel-wired strings with an intermediate base are best. These are the largest of the decorative bulbs; each one consumes about 10 watts.

When an outdoor bulb burns out, be sure to use the rubber washer when replacing it. These make the sockets waterproof.

Carefully follow all instructions issued by manufacturers for lighting equipment.

If planning extensive lighting for your home, have a competent electrician do the work.

If you connect strings of lights with add-on connectors, be sure you have no more than 60 10-watt bulbs in the total string.

Don't leave outdoor lighting equipment up when the holiday season is over. It will deteriorate if left on the house.

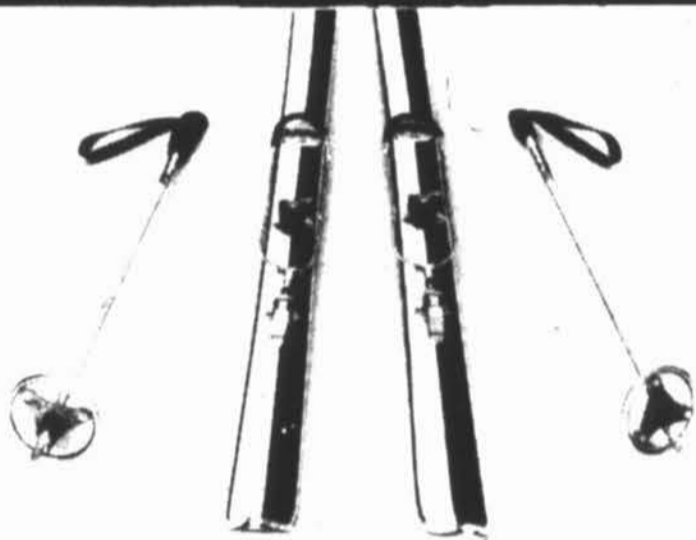

ALBERG  
— SKIS AND ACCESSORIES

RIEKER SKI BOOTS



COMPLETE LINES OF  
SPORTING GOODS — C.C.M.  
SKATES — HOCKEY  
EQUIPMENT ETC.

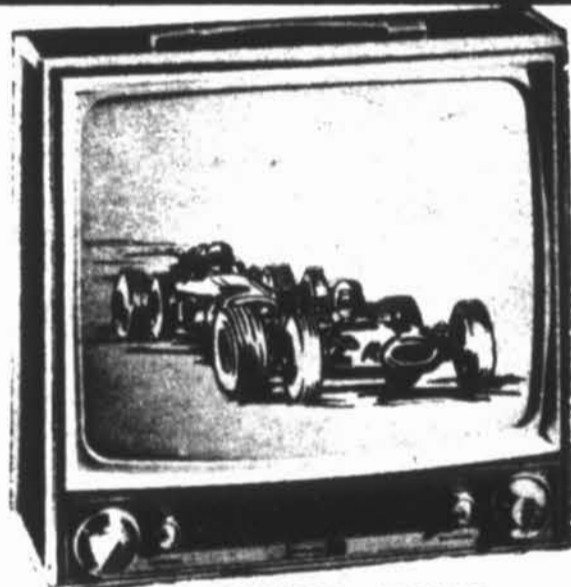

SANYO TV'S  
FROM \$139.00 WITH UHF



GRUNDIG

RADIO-PHONO-STEREO COMBINATION  
FROM \$329.00

Auto Heaters



"JOIN THE SNO-JET SET"  
TERMS AVAILABLE



HANDY ANDY



AUTOMOTIVE SPECIALISTS



CAR STEREO TAPE  
PLAYERS—FROM \$70.00

SHOPPING CENTER  
LABRADOR CITY  
PHONE 944-5141



the **CHRISTMAS STORE**

## Information column

FOR SALE - 1 set of drums, in new condition, interested persons please call at 730 Stirling Crescent or Phone 944-2525.

CAN ACCOMMODATE - A female boarder. Phone 944-5673.

Birthday greetings to Terry Mudge of Labrador City, who will be eight years old on December 24.

FOR SALE - 1 Baby high chair, in use only two months. 2 snow tires, 7.75 x 15; 1 Brownie uniform size 8. Telephone 944-2921.

WANTED - Accommodation needed for young couple with two children. Telephone 944-5576.

Anniversary greetings to John and Grace Grant. They will be celebrating their wedding anniversary on December 29th.

FOR SALE - 1 chesterfield and chair with covers. Phone 944-2385

WANTED TO BUY - A baby's chest of drawers, baby's high chair, playpen and jolly jumper. Must be in good condition. Please call 944-2404.

LOST IN THE VICINITY OF THE POST OFFICE IN LABRADOR CITY - 4 Keys on leather key chain. Printed on the case are 26B, 26F, and 26L, also one post office key, finder please Phone 944-2391.

## Bonspiel gets underway next month in St. John's

Forty-eight curlers from rinks all over the Atlantic Provinces and Quebec will converge on the St. John's Curling Club on January 15th for the 1970 Edition of the Atlantic Provinces Airways Bonspiel.

The Bonspiel, sponsored by EPA, is an annual event by invitation, and moves around each year. Last year it was held at the Blomidon Curling Club at Corner Brook.

The airline provides free

transportation for the visiting curlers from all parts of the Airline's network, and the entry fees plus many donations go to purchase the trophies, prizes and banquet which will be held this year at the Newfoundland Hotel.

The Bonspiel was organized by EPA some years ago in an effort to foster businessmen relations through the medium of curling for the various areas and communities served by the Airline.

The Curlers will arrive in St. John's on January 14th, register on the night of Jan. 14th and start curling on the morning of Jan. 15th. The games will then continue until Sunday, when the finals are played in the afternoon.

The Bonspiel is held in 4 Divisions, the first, or Airways Division is played for the Airways Trophy, donated by EPA. The second, for the Air Canada Trophy, the third for the Hickman Motors Trophy and the fourth for the Bowings Trophy.

Many local firms, as well as other Aviation Suppliers and Firms contribute to the Bonspiel and the Prizes, which, this year, will reach the \$3000 level.

The event has become one of the Curling highlights in The Atlantic Provinces, since its inception in 1963. It boasts the best prizes of any Bonspiel in the area.

### LEGAL CARD

**DAVID B. SPARKES**

Lawyer - Advocate  
Shopping Center Mall  
Phone 944-5555

## CHRISTMAS AND NEW YEAR'S CLUB HOURS

**WEDNESDAY, December 24th.**

LOUNGE OPEN FROM 2 p.m. to 6 p.m.

TAVERN OPEN FROM 9:30 a.m. to 6 p.m.

THURSDAY, DEC. 26th. CLUB CLOSED ALL DAY

**FRIDAY, December 26th.**

LOUNGE 5 p.m. to 11:30 p.m.

TAVERN 2:30 p.m. to 11:30 p.m.

**SUNDAY, December 28th.**

LOUNGE 3 p.m. to 6 p.m.

TAVERN 12 noon to 7 p.m.

**WEDNESDAY, December 31st.**

LOUNGE 8 p.m. to 2 a.m.

ADMISSION BY TICKET ONLY

TAVERN 9:30 to 6 p.m.

**THURSDAY, January 1st.**

LOUNGE 5 p.m. to 11:30 p.m.

TAVERN 2:30 p.m. to 11:30 p.m.

**THE ASHUANIPI SOCIAL CLUB**

### IMPROVISED HINGES

You can improvise some very strong and practical hinges for the cover of a tool box or a toy box by making use of some corner irons (sometimes referred to as mending plates). To attach these, locate the cover on the box and clamp it in place so that it will not shift. Then attach the irons to the cover with two

screws, and to the box itself with one screw each (Gene Von).

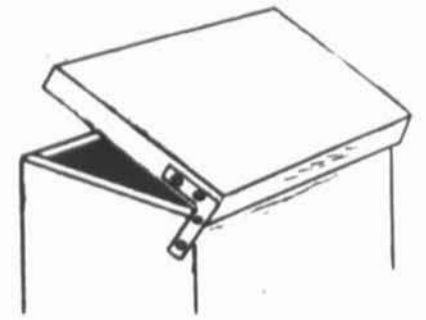

### Mind Teasers

If a certain number is multiplied by 1 less than itself, and 1/6 of this product is 4-1/3 times the original number, what is that original number?

ANSWER

27. Letting X equal the number, form equation: X times (X minus 1) all over 6 equals 4-1/3 times X. Simplifying, we have the equation: (X squared minus X) over 6 equals 13X/3. Solve for X.

Mrs. Jones bought some meat at \$1.12 a pound. If the price had been 4 cents less per pound, she would have received one pound more for the same amount of money she spent. How much did she spend?

ANSWER

\$30.24. Letting X equal the number of pounds she bought at \$1.12 per pound, form equation: 112X equals 108 times (X plus 1). Solve.



May this coming year be  
a time of happiness, joy  
and lasting peace for you

**CITY DRUGS LTD.**

**LABRADOR CITY**

# 'F.Y.I'

## Minor hockey standings

### MIDGET & JUVENILE DIVISION

	GP	W	T	L	TP
Saints	7	6		1	12
Carol Cleaners	6	2	1	3	5
J.R.S.	7	1	1	5	3

### SCORERS

Billy Lake	13
John Bullen	12
Gary Peckham	9
Gary Munn	7
John Murphy	7

### MOSQUITO DIVISION

	GP	W	T	L	TP
Flyers	6	4	2		10
Maple Leafs	4	2	2		6
Seals	4	2	1	1	5
North Stars	2	2	1	2	5
Hawks	4	1	1	2	3
Blues	5		2	3	2
Penguins	6		2	4	2

### TOP SCORERS

	GP	G	A	TP	
N. Kent	6	8	6	14	Flyers
M. Peckham	5	9		9	North Stars
G. Porter	6	6	1	7	Flyers
N. Peckham	6	6	1	7	Penguins
Martin	4	5	2	7	Seals

### PEE WEE DIVISION

	GP	W	T	L	TP
Canadiens	4	4			8
Maple Leaf	4	3		1	6
Kings	4	1	1	2	3
Bruins	4	1		3	2
Red Wings	4		1	3	1

### TOP SCORERS

	GP	GA	A	TP	
E. Lake	4	9	2	11	Canadiens
W. Reilly	4	8	1	9	Maple Leafs
S. Tuan	4	7	1	8	Canadiens
F. Lenoard	4	2	5	7	Maple Leafs
T. MacDonald	4	4		4	Bruins

### BANTAM DIVISION

	GP	W	T	L	TP
Royals	7	6		1	12
Braves	6	4		2	8
Wabush	7				7

### TOP SCORERS

	GP	G	A	TP	
T. Costigan	7	17	8	25	Royals
R. Snow	6	12	3	15	Braves
B. Bullen	7	12	3	15	Royals
G. Hunt	7	9	1	10	Wabush
M. Surritle	6	2	7	9	Braves

**BIG SPENDER GOODIES:**  
Some stores apparently aren't convinced that inflation is curbing luxury - goods sales. Neiman - Marcus Co., of Dallas, Texas, is offering to deliver 100,000 gallons of Aramis cologne to your doorstep in a tanker truck for only \$5 million. The company will even throw in refillable five-gallon jugs to make the gift a little more manageable. The chain of Texas specialty stores, has still other lures for big spenders in its Christmas catalog. For example, there's an 18-carat gold tape measure for \$350.00; 18-carat gold calling cards (a dozen for \$1,500.00); a \$10,600.00 kitchen computer, to help housewives conjure up the most perfectly computerized menus and balance your checkbook too; and a one-of-a-kind Kojah mink coat (each skin costs \$2,700.00) for between \$125,000.00 and \$150,000.00, depending on the style. For children, the company offers a petting zoo, complete with zoo keeper, for only \$13,750.00 per year. The zoo, of animals that can be petted, includes pairs of North American burros, New Zealand rabbits, goats, long-haired Shetland ponies and domestic white ducks. If that's too many animals for one household, Neiman suggests a baby girl elephant "guaranteed to grow to elephant size" for \$5,000.00.

# Greetings of the Season

## AND

# BEST WISHES FOR THE NEW YEAR

## THE LOCAL IMPROVEMENT DISTRICT OF LABRADOR CITY

## AND

# THE LABRADOR CITY RECREATION COMMISSION

## New CNIB service in Labrador

Mr. Edgar Hounsell, a blind resident of Labrador City, received the first talking book machine to be used in Labrador, last week. The machine is designed to play special tape cassettes supplied by the CNIB National Library at Toronto. These cassettes contain all types

of reading material normally found in libraries or printed books, including such periodicals as Readers Digest and Time Magazine. They are supplied free of charge to registered blind Canadians upon request and are handled "postage free" by the Canada Post Office. Mr. Ed. O'Brien, chairman of the CNIB,

Labrador Advisory Board, stated that these books are the newest in recording for the blind in Canada. Other machines will be supplied to the Labrador Board as they become available. Two other requests have already been received from blind residents of Labrador.

## Tidings of Joy

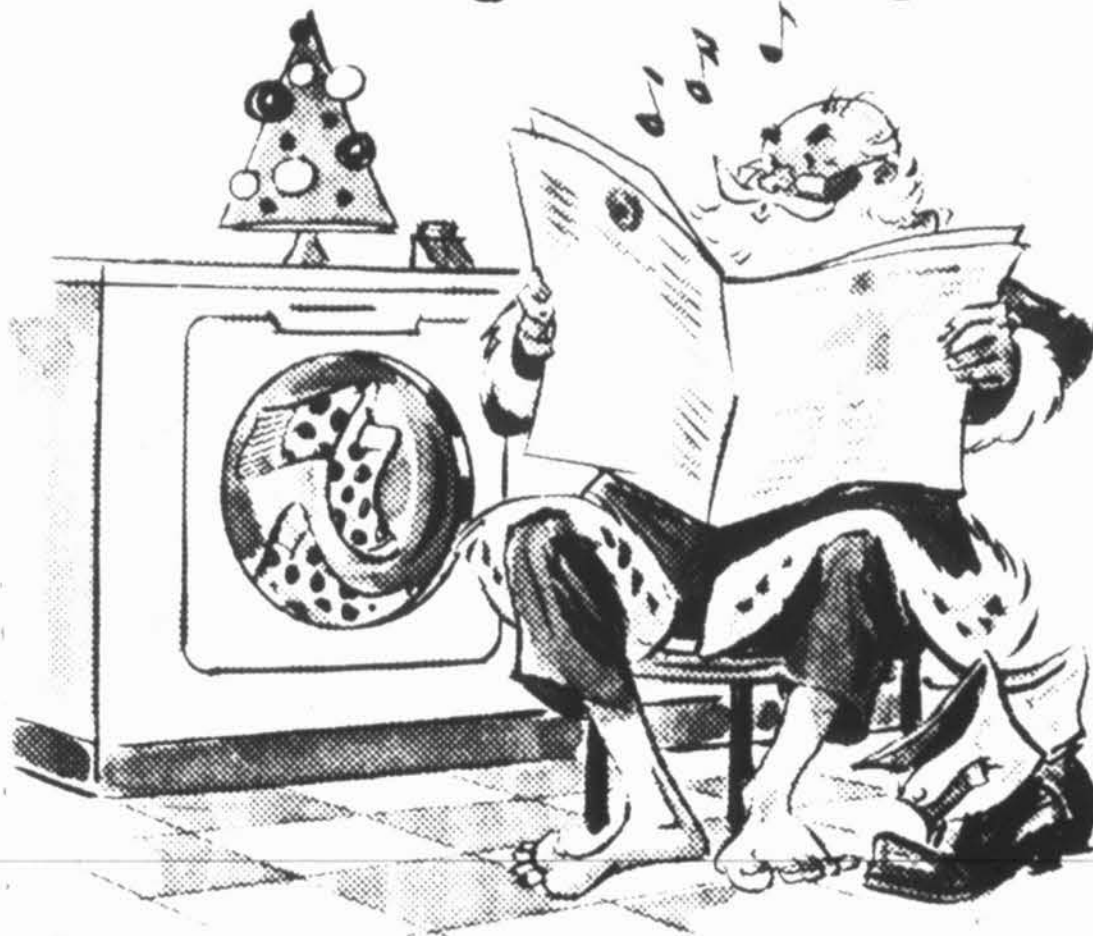

Just taking time out to wish you a very merry Christmas!

**CAROL LAUNDRY AND DRY CLEANERS**  
LABRADOR CITY



Wrapping up greetings to send to all our wonderful friends & patrons!

"Quality tools for all trades"

Shopping Center - Labrador City

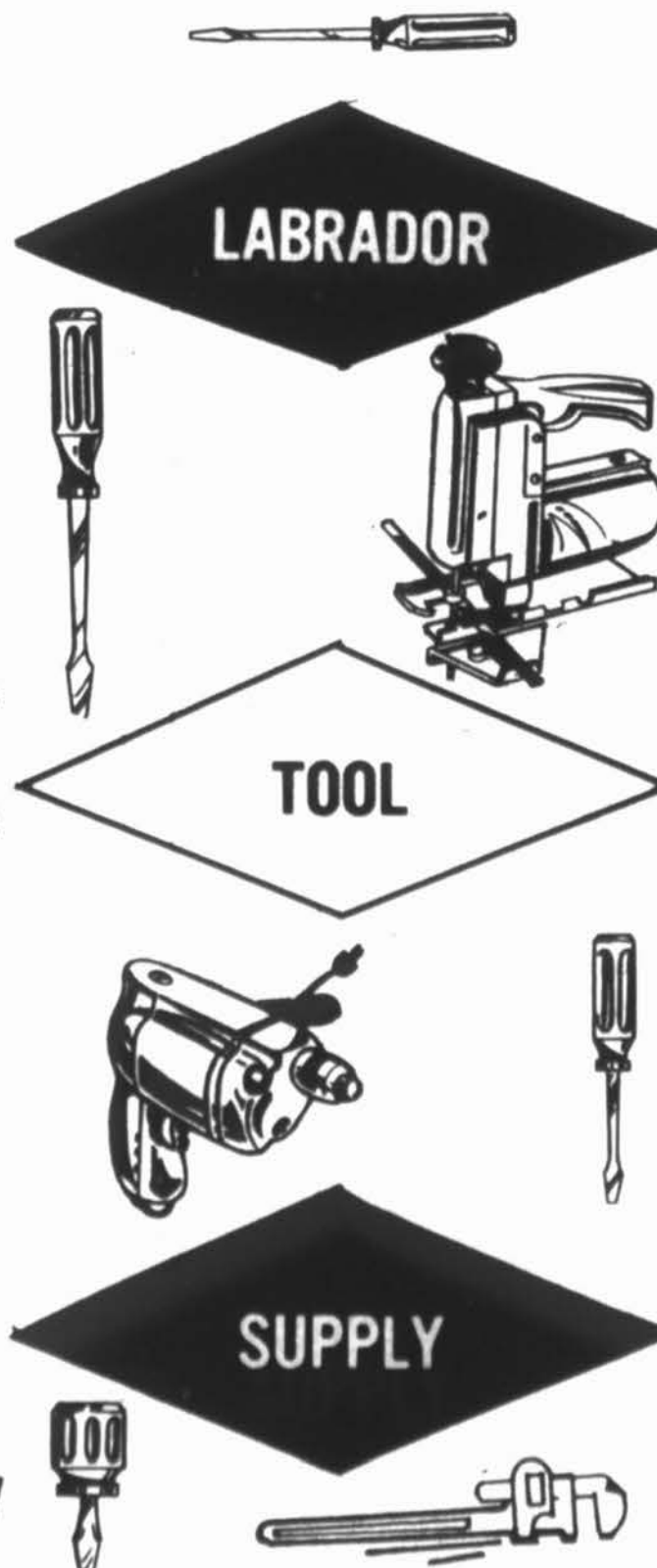

## Quotes

Silence is not always tact and it is tact that is golden, not silence.

The best thing to befall a man is to be born lucky.

He that plants thorns must never expect to gather roses.

Conscience is thoroughly well-bred and soon leaves off talking to those who do not wish to hear it.

Human beings are perhaps never more frightening than when they are convinced beyond doubt that they are right.

Even a flea doesn't jump merely for joy.

Friendship is a word the very sight of which in print makes the heart warm.

Youth would be an ideal state if it came a little late in life.

Friends are the thermometers by which we may judge the temperature.



We wish you peace and joy at this time and for always!

FROM

**TRANS-CANADA ADVERTISING**  
MONTREAL, QUEBEC

REPRESENTATIVE

**CLAR HORWOOD**  
LABRADOR CITY  
PHONE 944-2911

# Labrador West television programs

## WEDNESDAY, DEC. 24

- 4:30 - Edge of Night
- 5:00 - Strange Paradise
- 5:30 - Take Thirty
- 6:00 - Bobino
- 6:30 - La Boite
- 7:00 - Banana Splits
- 7:30 - Zoom
- 8:30 - McQueen
- 9:00 - Irish Coffee
- 9:30 - Wednesday Night Movie
- 11:30 - CBC NEWS

## THURSDAY, DEC. 25

- 3:30 - Christmas Company
- 4:30 - Cue The Angels
- 5:00 - Hi Diddle Day
- 5:30 - Take 30 (Special)
- 6:00 - Contes De Noel De M. Magor

- 7:00 - Songs by the Sea
- 7:30 - News Digest
- 8:00 - Chantons Noel
- 8:30 - Bill Cosby Show
- 9:00 - Nimmons N Nine
- 9:30 - Holiday Festival RCMP Festival Parade
- 10:30 - Children of The World
- 11:30 - CBC News

## FRIDAY, DEC. 26

- 4:30 - Edge of Night
- 5:00 - Strange Paradise
- 5:30 - Take Thirty
- 6:00 - Bobino
- 6:30 - La Boite
- 7:00 - Hi Diddle Day
- 7:30 - Super Six
- 8:00 - Singalong Jubilee
- 8:30 - Donald Lautrec
- 9:00 - Quelle Famille
- 9:30 - Laugh-In
- 10:30 - Mission Impossible

The IMF goes on a bizarre submarine voyage in an effort to recover a board of stolen money. Jim Phelps, with the aid of a pretty woman agent, puts pressure on a one-time war criminal to determine where the money is hidden.

11:30 - CBC News  
11:50 - Feature Film - Naked Street

## SATURDAY, DEC. 27

- 4:30 - Fabulous World of Skiing
  - 5:30 - Tour de Terre
  - 6:00 - Lassie
  - 6:30 - Bugs Bunny/Road Runner
  - 7:30 - Galloping Gourmet
- For a taste of France host Graham Kerr prepares "Chateaubriand Henri Quatre."

- 8:00 - Atome et Galaxies
- 8:30 - N.H.L. Hockey
- 11:00 - Les Couche-Tard
- 11:30 - CBC News
- 11:50 - Cinema

## SUNDAY, DECEMBER 28

- 4:30 - My World & Welcome To It
- A new maid who fears modern appliances provides plenty of problems for John Monroe.

- 5:00 - M. Surprise
  - 5:30 - Audubon
- Audubon Wildlife Theatre travels to scenic Nova Scotia to view the amazing 60-foot tides of Bay of Fundy.

- 6:00 - Hymn Sing
- Join the CBC Hymn Sing Chorus for spirituals, singalongs, and songs for the children.
- 6:30 - Wonderful World of Disney

A Irish sea captain searches for legendary pirate treasure.

- 7:30 - Ed Sullivan Show
- 8:30 - Aux Pays des Geants
- 9:30 - Volpone
- 11:00 - Weekend.

## MONDAY, DEC. 29

- 4:30 - Edge of Night
  - 5:00 - Strange Paradise
  - 5:30 - Take Thirty
  - 6:00 - Bobino
  - 6:30 - Charlie Chaplin
  - 7:00 - A Place of Your Own
- How water transportation has affected Canada.
- 7:30 - Aeronauts
- The Aeronauts become involved in a spy plot.
- 8:00 - Front Page Challenge
  - 8:30 - A la Seconde
  - 9:00 - Paradis Terrestre
  - 9:30 - Bold Ones

Craig Stevens guest stars as a gubernatorial candidate accused of the death of a campaign worker.

- 10:30 - Governor & J.J.
- Woman's intuition tells J.J. that her father has a secret admirer.
- 11:00 - Man at the Centre
- Man at the Centre discusses the problems that young boys face as they achieve sexual maturity.
- 11:30 - CBC News

## TUESDAY, DEC. 30

- 4:30 - Edge of Night
- 5:00 - Strange Paradise
- 5:30 - Take Thirty
- 6:00 - Bobino
- 6:30 - La Boite
- 7:00 - Swingeround
- 7:30 - Rocket Robin Hood
- 8:00 - Red Skelton Show

Walter Brennan and the rock musical group called Smith entertain on The Red Skelton Show.

- 9:00 - Rue des Pignons
- 9:30 - Moi et l'Autre
- 0:00 - Name of the Game

Dan Farrell travels to Florida to investigate a large-scale cattle rustling operation.

- 11:30 - CBC News

## WEDNESDAY, DEC. 31

- 4:30 - Edge of Night
- 5:00 - Strange Paradise
- 5:30 - Take Thirty
- 6:00 - Bobino
- 6:30 - La Boite
- 7:00 - Banana Splits
- 7:30 - Zoom
- 8:30 - McQueen
- 9:00 - Irish Coffee
- 9:30 - Wednesday Night Movie
- 11:30 - CBC News

# The youth column

by Sharon Bryans

There was a Christmas semi-formal dance held at the Labrador City Collegiate on December 15th, for the students of the amalgamated school in grades six to eight, and the grade six to eight students of Notre Dame Academy. The music was supplied by the Krystals. There was also a teen dance at the O'Brien hall on Friday December 12th. The majority in attendance were high school students who thoroughly enjoyed themselves. The highlight of the evening was when the Krystals played a Russian folk dance and everyone had a good laugh trying to do it. The dance ended at midnight and a bus service was provided to the shopping center.

The students in the area will be having their Christmas break from December 19th, to January

6th. The high school students have planned many celebrations for the holidays and plan to have a good time because they will be faced with exams within three weeks after arriving back at school.

The Christmas semi-formal for the high school was held on Saturday December 20th with the music provided by the Krystals.

I will report on this dance in detail in my next column.

On Wednesday afternoon, December 10th, the students of the high school were honored with a guest speaker, Doctor Robert McClure, the head of the United Church in Canada. He spoke to the students about his work and travels in India and China. Dr. McClure told about living and health conditions in India which we were unaware of. Mr. McClure informed the students how

they could help people in these countries, by joining organizations such as the peace corps or CUSO, or by sending donations to International Aid Organizations such as CARE and UNICEF. Doctor McClure enjoys the position of being the only layman who has been the head of the United Church in Canada. While in India he performed surgery on many leprosy victims, who had previously suffered from their physical abnormalities which they had contracted from the disease.

He informed us of the rough transportation methods in India in transporting patients, which seemed unreal to us in such a modern society. Dr. McClure was the most interesting speaker the students of the Collegiate have had on the stage and by the rapt attention paid to him, it was evident that everyone enjoyed his speech and learned something from it.

### NOW ON DISPLAY



NEW 1970 THOROBRED TRUCK CAMPERS & TRAVEL TRAILERS

Buy now or place order for spring delivery at great savings. Also complete line of accessories, gas fridges, heaters, stoves, etc. Prices reduced.

CAMPING & RECREATION EQUIPMENT LTD.

Just West of the Overpass, Topsail Road ST. JOHN'S  
Phone 368-5871, 368-2582  
Financing Available

Phone 282-6877 or 282-6632

## WESTLAB

FOR ALL YOUR FAVOURITE BEERS

India - Black Horse - Labatt 50  
Molson's Export - Dominion  
Blue Star - O'Keefe  
Molson's Canadian

HOME DELIVERY FOR SMALL CHARGE

ALSO PICK-UP SERVICE FROM HOTEL WAREHOUSE



## HAVE YOUR CARPETS AND FURNITURE CLEANED

by the Duraclean® Absorption Process

NO messy soaking—NO harsh scrubbing—NO upset house. Everything ready to use same day.

For FREE quotation, phone

RON SHORT Telephone 944-5512

## GUARANTEED

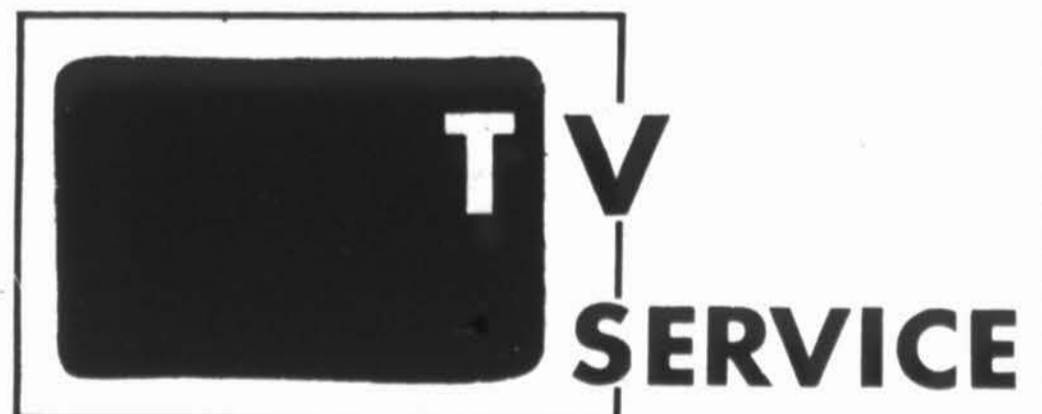

90-day parts and labor warranty

All our repair work is covered with a guarantee - your assurance of top quality service here always! You'll find our rates the most reasonable around, too!

EXPERT SERVICE 12 HOURS A DAY  
10 A.M. TO 10 P.M.  
AL'S ELECTRONIC CENTER  
PHONE 944-5268

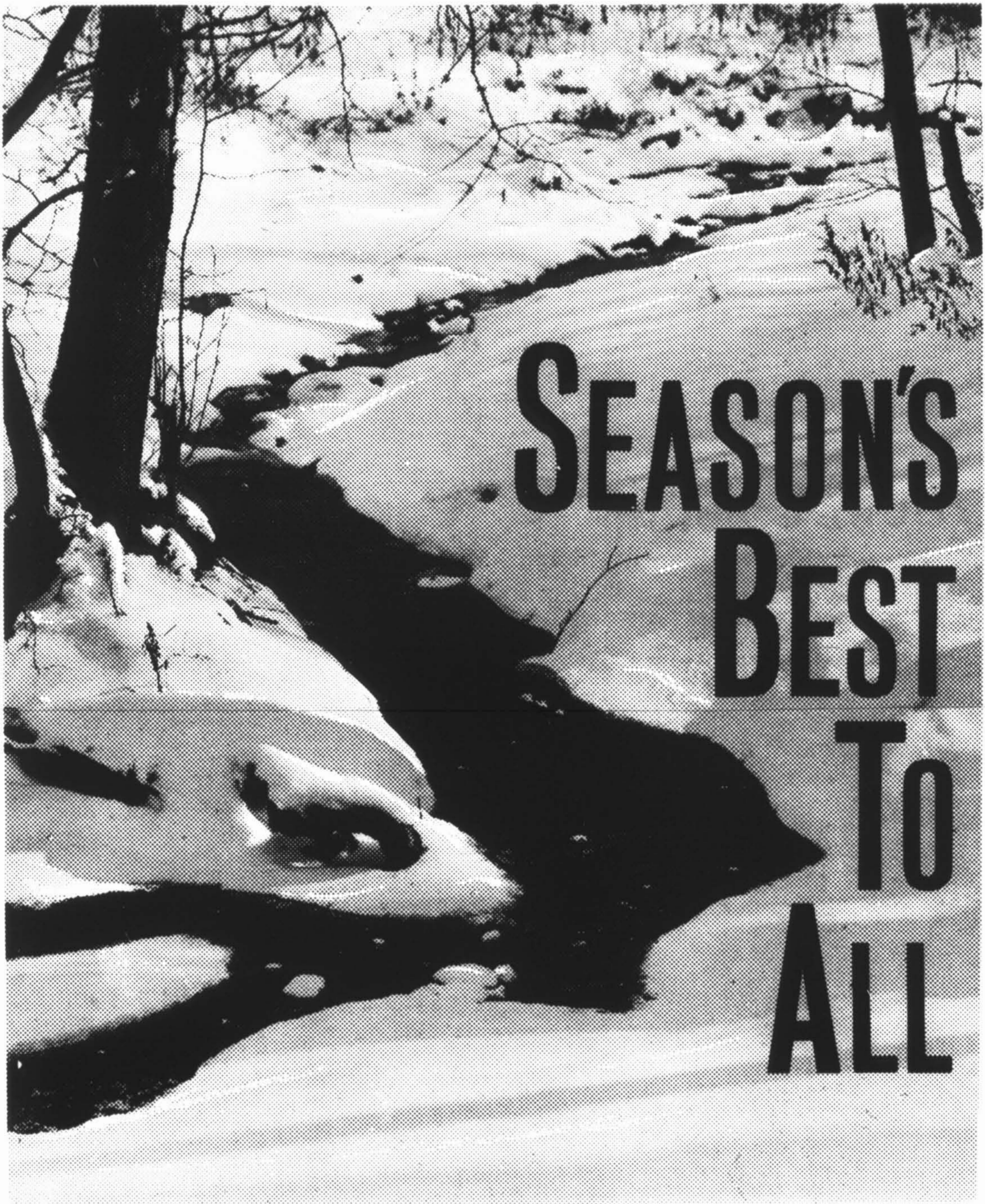

**SEASON'S  
BEST  
TO  
ALL**



SCW, INC.

**We would like to thank you, our loyal friends, for your patronage this year. It has been a real pleasure serving all of you.**



FROM  
THE MANAGEMENT AND STAFF  
OF

**BOWRINGS**  
LABRADOR CITY

# Peace On Earth



May the spiritual gifts of  
love and understanding be  
with you and yours this Christmas.

**MANAGEMENT AND STAFF OF**

**CAMPELL'S**



**SERVICE**

# Speaking of sports by Jack Drover

## HOCKEY "A" and "B" League

Two "B" League games and one "A" League game were played this week with the Royals B winning both their games and the Saints defeating Wabush Huskies 8 - 7 in the "A" League.

On last Friday night, the Royals defeated the Indians 6-3 and on Tuesday the Royals again displayed some late-game heroics to defeat Wabush 7-6. In this game Wabush was leading 6 - 4 with less than three minutes left when Joe Pollett hit for two goals in 14 seconds and then Bill Todd came through with the winner at 18.09. Other scorers for the Royals were Cyril Tarrant, John Mason and Job Blackwood while Tony Barton with 2, Tom Kent, D. Fitzgerald, J. Fitzgerald and Roy Kaoli

replied for Wabush.

In the high scoring "A" game Jean Letourneau led the Saints with two goals and two assists. Hubert Hynes and Don Hong also had 2 goals for the Saints with Ed Hong and Gary Pritchett registering singles. Bill Kelly led the huskies with 2 markers with singles going to Ed Kelly, Max Ollerhead, John Mercer, P. Dawe and Nev Hackett. Wabush outshot the Saints 55 - 49 with 8 of the 14 minor penalties going to the Saints.

Standings after two rounds in the "B" League see the Royals with 6 points, Wabush 4 points and the Indians with 2.

## VOLLEYBALL

A six team volleyball tournament was played in the J.R. Smallwood Collegiate gym

on December 12th and 13th. Teams entered in the two-day affair were Prince of Wales College from St. John's, J.R.S. Collegiate students, L.C. Collegiate students, and staff teams from J.R.S., N.D.A., and L.C.C. The final standings were as follows: P.W.C. 20 points; J.R.S. - 16 points, J.R.S. staff - 10 points; L.C.C. students - 16 points, L.C.C. staff - 6 points and N.D.A. staff winless in their 10 games. Following the draw a best of 3 playoff was held for the championship between P.W.C. and J.R.S.C. - with P.W.C. winning in two straight games.

## CAROL CURLING CLUB NEWS

The Annual Christmas Bonspiel was held at the Carol Curling Club on the weekend of December 13th and 14th with 24 teams taking part. The Bonspiel opened on Friday afternoon, ran all day Saturday and Sunday with a dance on Saturday night and presentation on Sunday evening.

The following people were rewarded for their efforts:

"A" Division Winners - Lorne Tkchuk, Gerry Headland, Al Christie and Shirley Dinon.

"A" Runner-Up - Denny Christian, Denise Beaumont, David Bohach, Carolyn Wells.

"B" Division Winners - Ralph Roberts, Betty Pitcher, John Rowe, Barry Roberts.

"B" Runner-Up - John Caverly, Wally Schafer, Gerry Simard, Michelin Bernier.

"C" Winner - Bob Brawley, Betty Blackwood, Pat Dwyer, Thelma Young.

"C" Runner-Up - Mike Brennan, Barb Lynch, Roger

## Christmas cantata presented

Celebrating the Anniversary of the Anglican and United Churches joint services, the Senior Choirs, presented on Sunday December 14th, A Christmas Cantata under the Supervision of Miss Coole.

From the very first notes of "Adeste Fideles" a shiver of emotion was felt by the audience for the unity of the choir, the perfection of intonation, and the harmony of the singing. The whole story of Nativity, was related by Mr. Robert Martin reading the different episodes from the Bible, and the accompanying choir was illustrating step by step the marvelous wonder of Christ's Birth.

Mrs. Audrey Sumner sang the soprano partitions perfectly, Mr. Albert Chatwood, an excellent tenor and Mr. David Selleck, a very impressive baritone. Our sincere congratulations go also to the Choir Director Miss Coole and the pianist Mrs. McIntyre.

Parent, Frances Bohach.

The Club would like to thank F. Lawson Ltd., and Burns Ltd. for donating turkeys and geese as prizes for the Bonspiel.

Meanwhile, the Club has its second school bonspiel schedules for the weekend of December 26th - 27th - 28th. Teams will be coming in from Schefferville and Goose Bay and maybe Sept-Iles. A teenage dance will be held at the Club on the 27th.

The Men's Club Playdown for the right to enter the British Consols will begin at the Club on Jan. 2nd. The Club is allowed to enter 3 teams this year and of course, the provincial playdowns are scheduled for here from January 30 to Feb. 5th.

## HERE AND THERE

Tickets are now on sale at the Curling Club for the New Years' Eve Dance. The Price is \$20.00

and these are available to members only.

The Carol Lakers lost both games by one goal to the Schefferville All Stars in Schefferville.

A Reminder that the Basketball League is scheduled to resume action again on January 14th.

Local hockey problems seem to be solved as both "A" and "B" leagues are now moving and drawing well. The Braves certainly are the team to beat.

A meeting of all people interested in playing broomball was held at the Arena last week. If you did not make the meeting and would like to play, you should phone Whit Kean at 2621 as soon as possible.



BEST WISHES  
FOR  
A MERRY CHRISTMAS  
AND  
A HAPPY NEW YEAR

FROM THE PRESIDENT  
AND EXECUTIVE  
UNITED STEELWORKERS  
OF AMERICA  
LOCAL 5795  
LABRADOR CITY



# WABUSH



SERVICE

STATION

# Entertainment corner for kids

**O**BSERVATION FUN. TRY TO DISCOVER 10 DIFFERENT PAIRS OF OBJECTS WHICH HAVE EXACTLY THE SAME NAMES.



HERE ARE TWO KINDS OF BATS, BILLS, COMBS, RACES, HANDS, LEAVES, NAILS, NUTS, PINS AND PIPES.

WHAT 8 GIRLS' NAMES WILL RHYME WITH THESE BOYS' NAMES?

- 1 RAY
- 2 DAN
- 3 MORRIS
- 4 EARL

ANSWER: 1. MAY 2. ANN 3. DORIS 4. PEARL

ANY RHYMING NAME WILL BE CORRECT.

- 5 HARRY
- 6 LEW
- 7 EDDIE
- 8 WAYNE

ANSWER: 5. GARRIE 6. SUE 7. HEDY 8. JANE

COVER HALF OF THESE CLOUDS, WITH A PIECE OF PAPER, TO READ THE NAME OF A PLANET.



**J**UST FOR THE FUN OF IT - SEE IF YOU CAN WRITE THE GIVEN NUMBERS IN THE BOXES TO GET A TOTAL OF 40 IN EACH OF THE TWO ROWS.

4	5	6
7	8	9
10	11	12

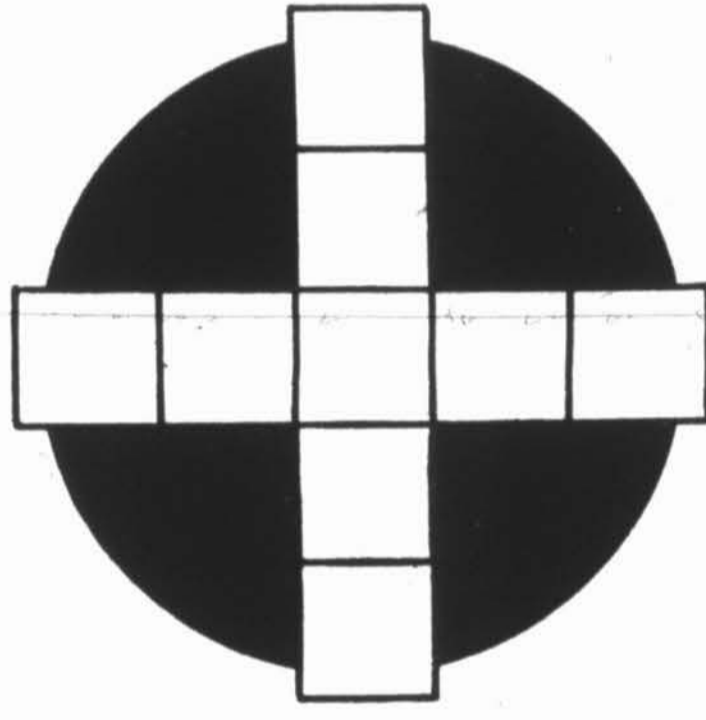

ACROSS: 5, 11, 8, 9, 7. DOWN: 4, 10, 8, 12, 6.

**TINKERBELL NURSERY SCHOOL**  
**OPENING JANUARY 6th, 1970**  
 St. Paul's Anglican and Carol United Church  
 Nursery Rooms  
 For Children from 3 to 5 years  
 Monday thru Friday -  
 \$25.00 per month  
 Trained Nursery Staff  
 Phone 944-5561 or 944-5708

JIM SWANSON AND SONS  
 YOUR AUTHORIZED YAMAHA DEALER  
 FOR LABRADOR CITY AND WABUSH  
 SPORT CYCLES, SNOWMOBILES  
 OUTBOARD MOTORS - BOATS  
 AND SKIS  
 CALL JIM NOW AND ENQUIRE  
 ABOUT THE 1970 YAMAHA SNOWMOBILE  
 MODELS AVAILABLE - SL 338 - 24 HP  
 SL 396 - 27 H.P. WIDE TRACK  
 "IT'S A BETTER MACHINE"  
 TELEPHONE 944-5852



Hope your holiday menu includes all the joys of the season! Best wishes for health, wealth, and happiness to all our good friends!

**UNGAVA RESTAURANT**  
 Shopping Center - Labrador City

## The Bible today

Spanish Bibles, printed in Glasgow, Scotland, for distribution in Mexico . . . New Testaments in the Tigrinya language printed in London, England, for reading in Ethiopia . . . Gospels of John in Twi Asante printed in the United States for use in Ghana . . . Spanish Selections printed in Caracas, Venezuela, for dissemination throughout Latin America.

Historically the New York City headquarters of the American Bible Society and the London base of The British and Foreign Bible Society have been the main centres for the production of Bibles, Testaments, Portions and Selections. While large quantities of such materials still emanate from these centres, increasingly production is carried out elsewhere. Today God's Word is printed in more than 70 locations around the globe, making it literally the most universal of all books.

## Greetings

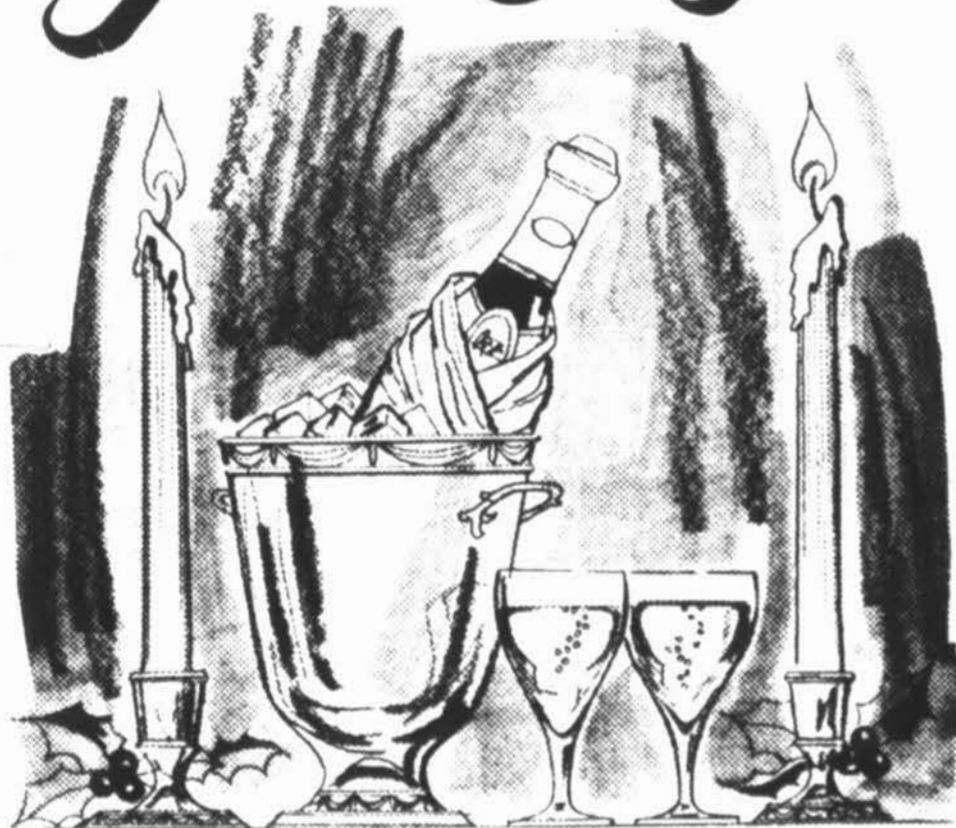

*Good Cheer to All!*

**WESTLAB AGENCY  
LIMITED**

**WABUSH  
PHONE 282- 6877**

## Solve — a — crime

you are  
the  
detective

BY A.C. GORDON

The body of the wealthy, middle-aged socialite, Mrs. Margaret McGregor, lies on the floor of her bedroom. Clad in a blue dressing gown, she lies on her side, her hands still tightly clenched over her stomach. You stoop and pick up in your handkerchief the small bottle lying on the floor next to her, and after unscrewing the cap and smelling what remains of the contents you immediately recognize the odor of one of the fastest-working and lethal of poisons.

The bereaved husband, Ralph McGregor, a handsome young man whom you judge to be at least ten years younger than his late wife, is nervously pacing the floor behind you. "I just didn't have enough warning of her intentions to stop her!" he explains. "She swallowed the poison out of that bottle and immediately dropped to the floor as though she had been shot...writhed with pain for a couple of seconds or so, then she was dead!"

You remain silent as the young man makes an obvious attempt to control his emotions, then he resumes: "Margaret and I had our little difficulties, of course....just like any married couple. She was bothered by the fact that I'm a few years younger than she, and whenever I happened to pay a little polite attention to some younger woman at any social affair we attended, she would become very angry. Earlier this evening we had an unusually violent quarrel. We had been at a cocktail party late this afternoon, and Margaret really lost control of herself just because I spent the greater part of an hour sitting with a very attractive, unmarried girl who was there. Margaret was very bitter later as we drove back home here.

"Then when we arrived home, she got out of the car and stormed into the house and upstairs to her bedroom here. As soon as I put the car away in the garage, I followed her upstairs with the intention of trying my best to calm her down. But when I came into the room here, there she was standing in the middle of the floor holding that little bottle. She acted like she was out of her head, exclaiming, 'I've had enough...you show all the time that you're tired of living with me....life isn't worth the effort anymore.'"

McGregor shakes his head bewilderedly. "Believe me, I didn't think she really meant it, but...."

You gaze thoughtfully about the room for a moment, then ask, "Did you touch her or anything at all since this happened and before I arrived?"

"Not a thing. I went downstairs and used the phone there to call you....remained there until you arrived."

"Well," you say, "the story you've told me is a pretty good one, but there are a couple of inconsistencies that make me suspect you haven't told the truth!"

What ARE those "inconsistencies?"

### SOLUTION

First, although the victim's death was almost instantaneous, the poison bottle was capped. Most certainly she would not have had time to screw the cap back on after swallowing the lethal dose. And also, why the dressing gown so soon after her arrival home from a cocktail party and in view of her supposedly mad rush to the bedroom to do away with herself?



**F.W. WOOLWORTH  
COMPANY LIMITED**

**SHOPPING CENTER**

**LABRADOR CITY — PHONE 944-5355**

# Mining: resource development may be the key to exports in the seventies

Exporters, as they become convinced that the great trade boom of the sixties is beginning to fade, are taking a hard look at their prospects for the seventies.

For some exporters, especially those in the resource industries, even a cursory examination of world markets indicates that the demand for Canadian minerals will be buoyant. For others, especially manufacturers, it is clear that the competition is going to be tough because every other country wants to expand its share of the world market too. But gradually, the doors are opening for changes in structure that should give Canadians a sound base for future exports. Canada has a supply of minerals that other countries need. Some of them are ready for a boom in sales:

Potash and uranium, now in a slump, are expected to surge ahead in the mid-seventies.

Large coal contracts have been signed with Japan. Gas

exports are expected to rise quickly and oil sales could also boom, depending on how North American oil policy develops.

Nickel and copper sales look good, especially with political difficulties in the African and South American copper producing countries. New resources such as heavy water and electric power could find buoyant markets in the U.S. if Canada should develop extra capacity.

Resource based exports now account for about 65% of Canada's foreign sales. But the growth potential for these goods is less than that for manufactured goods. In the sixties, for example, Canada's sales of finished goods increased by 31% a year. In the seventies they will also play an important part in increasing Canada's share of world trade.

## COMMODORE MINING EXPLORING IN NEWFOUNDLAND:

Commodore Mining Co., of St. John's, Newfoundland, has made numerous investigations of properties over the past three years, Lewis Murphy, president, advises shareholders. Geological mapping, stream and soil sampling programs, he says, have been continuous. Large areas of the Avalon Peninsula have been investigated and several snort holes were drilled on the Cape Broyle prospect without encountering ore grade mineralization. However, further detailed work will be carried out there at a later date. In the Argentinia-Placentia concession area, preliminary investigation has been carried out. An interesting copper-lead occurrence is reported and further work is planned.

A concession area of approximately 500 sq. miles on the Great Northern Peninsula of Newfoundland and optioned to New Jersey Zinc Exploration Co. (Canada) Ltd., subsidiary of New Jersey Zinc Co. Since exploration was started in July, 1968, copper and lead values have been found and a detailed investigation of the showings is projected.

Last year the company also optioned a large area of approximately 300 acres to Cominco Ltd., lying west of the ground optioned to New Jersey Zinc. A mineralized outcrop drilled by Cominco to shallow depth has indicated zinc mineralization over an 80 ft. width. Diamond drilling in this area is planned this winter.

A large block of ground was also optioned to Texas Gulf Sulphur Co., which this year carried out an airborne

geophysical survey. Overall results are described as poor, but an anomalous area was picked up at the northern end of the concession in the vicinity of Triangle Pond, west of Holyrood. Copper mineralization was found in places a survey has been carried out, to be followed by diamond drilling.

According to the latest edition of Canadian Mines Handbook Commodore Mining Co., Ltd. has its executive offices at 524 Water Street, St. John's, Newfoundland. The officers and directors are L. Murphy, president and managing director; Fred. W. Russell, vice-president; John W. Mahoney, M.H.A., secretary-treasurer, William R. Smallwood, M.H.A. Director.

## JAPANESE MINERAL IMPORTS

Value of Japanese imports of

metal ores reached an unprecedented figure of \$1.6 Billion in 1967, exceeding by 53% the preceding year's all time record level. Last year's imports by Japan came close to \$2.0 billion. High rates of industrial production should bring this figure much higher in the next decade.

Iron ore imports are a typical example and an important one. Imports of iron ore totalled 57,000,000 tons in 1967 with a value of \$718,000,000.00, up about 18% over the previous year. For 1968 the total value reached \$800,000,000.00. Most of the iron ore imports come from North America, Southeast Asia, Chile, Peru, Australia, and Brazil. Imports from Africa, Pacific countries and the Communist bloc nations have been increasing. Australia alone provided 6,300.00 tons of iron ore in 1967. It is expected that iron ore concentrates, will make large gains in the seventies.



good times!  
good cheer-  
at Christmas!

To our very good friends,  
best wishes for the holiday season

**INTER CITY  
TRANSPORT  
LABRADOR CITY**



BUY DIRECT  
AND SAVE

If we are not represented in your area

1970  
SNOWMOBILES

Now on Display. Prices start at \$695.00 (for the 14 h.p. model). Other models available to 60 H.P.

Complete line of clothing Trailers and Accessories in stock.

For the BEST prices quality and variety contact your

SKIROULE DEALER  
CAMPING & RECREATION  
EQUIPMENT LTD.

Just west of the  
Overpass, Topsail Road  
ST. JOHN'S  
Phone 368-5871, 368-2582  
Financing Available  
(Dealer Enquiries Invited)



Wishing you the  
joys of the Christmas season

**THE NEWSTAND  
Dave Poole  
(RECREATION CENTER)  
WABUSH**

# Advice on wall-to-wall carpeting

## CONSUMERS' ASSOCIATION OF CANADA

Moving into a new home or just planning on redecorating your present home? Wall to wall carpeting is still one of the most popular "looks" in home decorating today.

But when it comes to buying carpeting, many customers have little knowledge of the product they intend to purchase. Furthermore, the variety of fibres, brands and prices only add to the dilemma. So before you invest, Consumers' Association of Canada suggest you investigate.

A buying guide on "Carpets and Rugs" is available free on request and will provide you with accurate information on the various fibres, types of weave and quality of carpeting required for the various "wear areas" in your home.

A few pointers to remember:

Plain colors show dirt more readily than patterned ones.

Patterns with darker colors show dirt less than those with light colors.

Light colors tend to fade more rapidly.

Complaints of poor wear are often due to selecting the wrong grade of carpet for the purpose.

There is little difference in wearing qualities between all-wool and 80-20 wool-nylon blends.

In heavy traffic areas, carpets with an even pile texture retain their original appearance better than sculptured effects, as the hard-twist yarn or uncut loop pile gives better wear than the more luxurious soft, plush types.

All nylons in plain colors show considerably more staining and soiling than wool carpets.

When it comes to laying your wall to wall carpeting one thing to remember is that an underlay will extend the life of any

carpet. Buy the best you can afford, especially for stairways. There is a maxim about underlays well accepted by all who know carpets: "A poor carpet needs one; a good carpet deserves one."

The main function of an underlay is to prolong the wear life of the carpet by adding resilience and protecting the backing from abrasion on a hard floor surface. It also adds to the qualities of warmth and comfort inherent in a good carpet.

No type of underlay is ideal in all respects. Jute has less resilience than hair-felt or rubber so that it should not be used for heavy wear areas. Waffled sponge rubber has excellent resilience, good ventilation and resistance to mildew but this is the most expensive type.

For installation of wall to wall broadloom, a reputable layer is essential. Skill and experience

are most necessary because carpets improperly laid will stretch and buckle during use. "Power stretching" gives best results but stretching with a "knee-kicker" gives good results when used by an expert. Tacking is the most common way of fastening carpet edges. However, an increasing proportion of carpets is being laid now by a newer system. Strips of wood, with pins angled to grip the carpet edge, are nailed to the floor adjacent to the skirting to give a finish which eliminates the indented edges caused by tacking.

When buying a carpet, the quote given by the store should include the cost of the carpet, underlay and installation. Have the dealer put in writing exactly what his price includes and exactly what type of material will be provided. Ask for small samples so that you can compare

the carpeting and underlay when it is delivered.

Despite the attractive advertisements proclaiming free underlays, free installation and other free attractions, common sense indicates that you get "nothing for nothing", so if the dealer hedges at these simple requests, shop elsewhere there are reputable dealers willing to do business with you.

There is so much to carpet buying that you cannot see or judge that you are forced to rely on a brand name and a knowledgeable and reputable salesman or dealer. Shop at reliable retail outlets and you will at least be partially protected.

To get a buying guide on carpets, free in single copies only, write Consumers' Association of Canada, 100 Gloucester St., Ottawa 4. Please mark your envelope "Carpets".



May the blessings of the Christ Child be with you and your family

**WABUSH  
RECREATION  
ASSOCIATION**

### TRACK MACHINES



### P.P.T. AND PLAYCAT MACHINES

Goes anywhere any time. Ideal for sportsmen, lumber men, utility crews. Powerful motor, forward and reverse gears. Weight 650 lbs., tows up to 2000 lbs. Prices start at \$1595.00. Financing available.

CAMPING  
& RECREATION  
EQUIPMENT LTD.  
JUST WEST OF THE  
OVERPASS, TOPSAIL ROAD  
ST. JOHN'S  
PHONE 368-5871, 368-2582

ALL CLASSES  
OF  
INSURANCE  
(except life)

GERALD NEARY

Representing  
R.C. Anthony Insurance

PHONE  
282-6617  
after 5 p.m.

All Day Weekends.

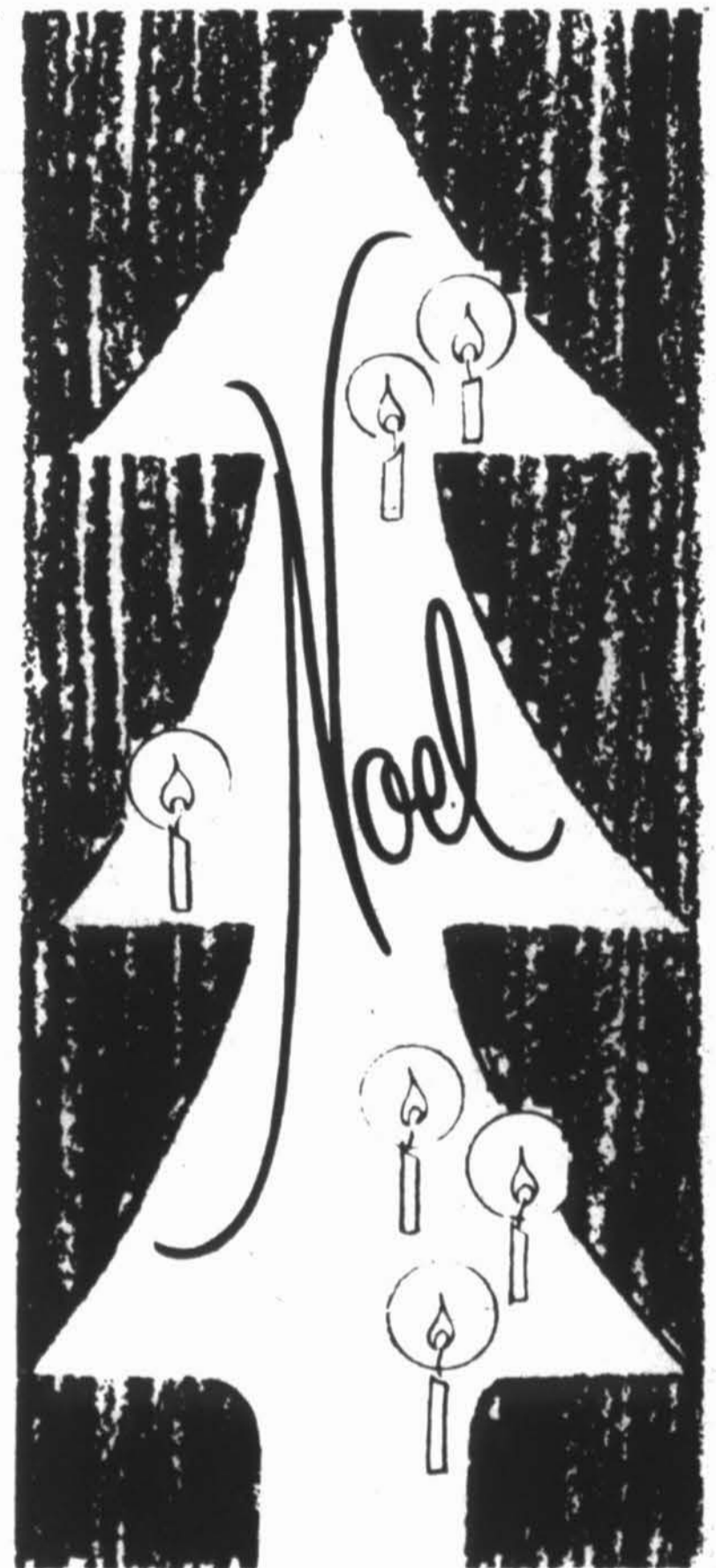

May the holiday season  
glow brightly for everyone!  
Greetings from

**THE NEW  
LABRADOR PARTY**

# Information is needed on credit applicants

by

Consumers Association of Canada

With the increased use of credit by consumers, the need for information on individuals applying for credit is understandable.

Currently outstanding consumer credit in Canada totals more than \$8 million and the extension of credit is not an automatic privilege - about 50 per cent of applications for cash loans are refused.

In return for the granting of

credit, one must expect a certain amount of reasonable scrutiny of what most people consider their own private business. This usually is the function of a credit reporting agency, or credit bureau.

The other major group is that of the "investigating" agency. The main distinction is that these bureaus investigate much more actively, by telephone or personal interview, individual case histories referred to them

by clients. Several agencies include both operations.

There are two types of credit fact-gathering agencies. The first compiles files and operates on the basis of exchange of information between credit-grantors. It may supplement its information from press clippings to complete the file.

The main purpose for which information is sought from credit bureaus is the assessment of applications for credit, but enquiries from intending employers, insurance companies and companies dealing in the bonding business are frequent.

By and large, bureaus strive earnestly for accuracy and fairness but mistakes can and do occur. When this happens, the results can range from mild inconvenience to serious damage to reputation.

As a result of many consumer complaints directed to the Consumers' Association of Canada, CAC approached the federal government to request legislation to protect the individual consumer from inaccurate and erroneous information being included in files without their knowledge.

CAC believes that consumers should be able to see without difficulty their credit rating files and to arrange for correction of untrue items which have been worked into the file.

The Associated Credit Bureaus of Canada maintain

they will disclose "to any consumer" information on file. However, CAC has not found this to be entirely true.

Consumers' Association of Canada believes there is a need for realistic legislation and enforcement in the credit privacy field. Credit reporting agencies should be licensed in order to regulate their activities in collecting and reporting information for the protection of individual privacy, reputation and economic security.

In a Canada-wide survey, conducted by CAC members anonymously, there was a wide range of attitudes by credit bureaus when individuals approached them on questions of privacy. Some bureaus were willing to show credit files, others flatly refused to give information about an identification. One required a

\$2.50 fee for examination of the file only if credit had been refused by a particular firm. In certain areas, a married woman must assume the credit rating of her husband and cannot see her credit rating file unless accompanied by her husband.

It is up to you to safeguard your reputation - for in a very real sense, reputation and privacy once lost can never be regained.

The vast majority of credit reporting agencies are reputable and strive to give accurate information but mistakes do occur and there are always the fly-by-night operators.

If you visit your local credit bureau or reporting agency with a request to view your file, we would like to hear their reaction to your request. Write Consumers' Association of Canada, 100 Gloucester St., Ottawa 4, Ontario.

## A SOLDIER & HIS GOD

This poem was found on the body of a nineteen-year-old soldier in Vietnam and appeared in the Becker County Record, Detroit Lakes, Minn.

Look God: I havenever spoken to you, but now - I want to say: "How do you do?" You see God, They told me you didn't exist and like a fool - I believed all of this.

Last night from a SHELL HOLE I saw your Sky - I figured right then they had told me a lie.

Had I taken the time to see the things You made, I'd know they weren't calling a spade a spade.

I wonder, God, if you'd shake my hand.

Somehow - I feel you will understand.

Funny, I had to come to this hellish place,

Before I had time to see Your face.

Well, I guess there isn't much more to say

But I'm sure glad, God, I met you today.

I guess the zero hour-hour will soon be here,

But I'm not afraid since I know You are here.

The signal - Well, God - I'll have to go

I like you lots - this I want you to know.

Looks like this will be a horrible fight,

Who knows - I may come to Your House tonight.

Though I wasn't friendly with You before,

I wonder God - if You'd wait at your door -

Look - I am crying, me shedding tears,

I wish I had known you these many years.

Well, I'll have to go now, God - goodbye

Strange - since I met You - I'm not afraid to die.

# GLAD TIDINGS



*Only the Best  
to you and yours  
at Yuletide!*

**THE MANAGEMENT AND STAFF  
OF  
THE BANK OF NOVA SCOTIA  
LABRADOR CITY**

## GREETINGS



May all our wonderful customers  
enjoy the very best of holidays!

*Ayre's*

**WABUSH PLAZA**

# Christmas stamps 1970

An imaginative Christmas stamp design project directed to an estimated 6,000,000 Canadian children under the age of thirteen has been launched by the Canada Post Office.

Expressing the theme "What Christmas means to me," Canadian children from coast to coast are invited to contribute their own drawings, which will be used to produce distinctive stamp designs reflecting the originality and freshness of young minds. Departments of Education in all Provinces are co-operating with the project, which will coincide with the International Education Year in

1970. Traditionally the Canada Post Office issues two special stamps each year to mark the Christmas season and normally these stamps, as is the case of all philatelic products, are designed by professional artists. Several designs by Canadian children will be used for Christmas 1970.

Children are invited to participate in the project by submitting their personally executed designs between December 1, 1969 and January 15, 1970. Selection will be made initially on a provincial basis and subsequently, at the national level. To assist with the

pre-selection of designs, the the aid of provincial panels including directors of art galleries, artists, art directors, and members of the advisory committee on stamp design.

When final selections on the national level have been made by the advisory committee, the Post Office plans to invite the successful young enterants, with a parent or guardian to Ottawa where they will be able to view the production of stamps from their drawings. Later, with the aid of the galleries, touring exhibitions of the drawings and designs submitted will be organized for the public.

### ASPHALT TILE

Marks on asphalt tile flooring, which refuse to yield to ordinary scrubbing, can be removed by rubbing the surface lightly with some No. 00 steel wool, using a concentrated solution of neutral soap or cleaner in some warm water - (Gene Von).



### Look for the good

This world a better place would be  
If we would only try to see,  
The good in everyone  
Just folks like you and me.

Look for the good in everyone,  
Some good You're sure to find,  
to err is human, we are told,  
But to forgive, Divine.

A gracious word, a kindly deed  
A friendly smile to cheer  
Give courage to a fainting heart  
And helps one's Cross to bear.

A golden opportunity  
Is given to us each day,  
to scatter seeds of kindness as  
we journey on life's way.

And when the reaping shall come,  
A hundred - fold - twill yield  
If we for Jesus sake have toiled  
In God's great harvest field.

I. O. S.  
OF CANADA LTD.

P.O. BOX 1022  
LABRADOR CITY

HENRI ETHIER  
RESIDENT REPRESENTATIVE FOR LABRADOR

TEL. 944 - 2319

*Peace on Earth*



Good Will To All  
Men This Christmas

## DUTH TRADING LIMITED

AMUSEMENT AND  
VENDING MACHINES  
LABRADOR CITY



EXTENDS SEASONS GREETINGS  
TO ITS  
MEMBERS AND FRIENDS

ROYAL CANADIAN LEGION  
BRANCH 57 WABUSH

## Sir Wilfred Grenfell Hotel CHRISTMAS AND NEW YEAR'S BAR HOURS

CHRISTMAS EVE, LOUNGE AND TAVERN  
CLOSES AT 6 P.M.

CHRISTMAS DAY, LOUNGE AND TAVERN  
CLOSED ALL DAY

DECEMBER 26th., LOUNGE OPENS  
5 P.M. TO MIDNIGHT,  
Tavern 2 P.M. to midnight

NEW YEAR'S EVE, LOUNGE OPEN  
FROM 8 P.M. to 2 A.M.,

ADMISSION BY TICKET ONLY

Tavern Closes at 8 P.M.  
New Year's Day Lounge Open 5 p.m. to 12 midnight,  
Tavern open 2 P.M. to midnight.

# this week in ASTROLOGY BY CARL PAYNE TOBEY ILLUSTRATED BY DEGRAZIA

## PAST



## THE DIVIDED WATERS

And God said, let there be a firmament in the midst of the waters and let it divide the waters from the waters. And God made the firmament, and divided the waters which were under the firmament from the waters which were above the firmament; and it was so. And God called the firmament Heaven. (Genesis 1:6-8.)

Firmament usually means the sky. It could have meant the Air signs of the zodiac. While the Water signs implied emotion, the Air signs implied intelligence. While the sky does not divide waters and there are no waters above the sky, the zodiacal Water signs are divided and there is always an Air sign (plus an Earth and a Fire sign) between any two Water signs. The word heaven could have appropriately been associated with mind and intelligence.

## FUTURE



## TOBEY'S PREDICTION:

An ominous week unless you realize that the only real security is within yourself. Look forward, not backward. The more you can simplify life the better. The important factor is your freedom. Don't throw it away. See what you can get along without. Don't be a prisoner of habit. There will be changes but self-sufficiency will be your most important asset. Look through the artificialities of life to become a more stable being on the inside. This is an important time. Don't incur any debts. Don't over-eat. Think in terms of life rather than possessions.

© 1969 by NEA, Inc.

## PRESENT

### THE GEMINI PLAYGIRL

She's here today, gone tomorrow. She changes her mind. It isn't easy for her to decide whether you are the one she desires. She has to study all the men. She analyzes them, synthesizes her information and then makes a decision but she might change it in the face of a new man. She thinks fast and you may have trouble keeping up with her. While she plays she still thinks. She is seeking the ideal man and he doesn't exist. Nevertheless, she is a lot of fun as long as you have her around.



## YOUR WEEK AHEAD

- ♈** **ARIES**  
Mar. 21-Apr. 19  
Don't make commitments. Judgment of authority can be wrong. Wednesday and Thursday poor.
- ♉** **TAURUS**  
Apr. 20-May 20  
Best keep on a cash basis. Don't borrow money if you can avoid it. Friday and Saturday unstable.
- ♊** **GEMINI**  
May 21-Jun. 21  
Avoid legal entanglements. Weekend negative for any travel. Partnership matters can bring some problems.
- ♋** **CANCER**  
Jun. 22-Jul. 22  
Stay out of complications by not entering into any new agreements or partnership arrangements.
- ♌** **LEO**  
Jul. 23-Aug. 22  
Guard health and that of those around you. Try to avoid starting any new projects.
- ♍** **VIRGO**  
Aug. 23-Sep. 22  
Monday through Wednesday mixed. Caution in all matters. A wait-and-see policy best. Relax a bit.

- ♎** **LIBRA**  
Sep. 23-Oct. 22  
Sunday and Monday hold uncertainties but improve Wednesday and Thursday. Judgment best then.
- ♏** **SCORPIO**  
Oct. 23-Nov. 21  
Hold up any decisions or important action until Friday and Saturday when you are more stable.
- ♐** **SAGITTARIUS**  
Nov. 22-Dec. 21  
Avoid changes or trips till next weekend. Early days warn against action leading to future legal problems.
- ♑** **CAPRICORN**  
Dec. 22-Jan. 19  
Stick to a conservative policy. It is important at this time. Don't buy. Wait. You'll gain in end.
- ♒** **AQUARIUS**  
Jan. 20-Feb. 18  
Take no risks just now. Adopt patience. Wait until things fall in the groove where you want them.
- ♓** **PISCES**  
Feb. 19-Mar. 20  
Take your time. Don't allow emotion or enthusiasm to lead you down the wrong alley. Next week is better.

### AN ABSTRACTIONIST

A very religious man in his own way, Dr. Myron S. Allen quit the establishment, after many years of teaching physics at the university level, to teach morphological thinking to space engineers so they could invent. Both Dr. Fritz Zwicky (discussed last week) and Dr. Allen are Aquarians. They are bent on changing the world and the educational system for the better, and their most important tool is the use of intuition (not recognized by the old school of materialism). Dr. Allen operates the Creative Growth Center at Los Gatos, California. He is concerned with life as cause rather than considering matter as cause. He is a symbol of the new physicist.



# HOLIDAY SPECIALS

DUFO

SPECIAUX DES FETES

16 LB. UP

# TURKEY 43

GRADE  
"A"  
CRY-O-VAC

EVISCERATED



DINDE

CATEGORIE "A" CRY-O-VAC  
"DUFO" TENDRE - PRETE POUR LE FOUR

BACON

MAPLE LEAF  
PQT. 1 lb. PKG.

89¢

HAM

READY-TO-SERVE  
SHANKLESS & SKINLESS LB.

79¢

JAMBON

AVEC OS PRET A MANGER

## BUTTERBALL TURKEYS

ALSO AVAILABLE AT SLIGHTLY HIGHER PRICES

MINCED PORK

3 LBS.

1.65

FREE "MONARCH PIE CRUST"  
GRATUIT "CROUTE A TARTE MONARCH" AVEC  
L'ACHAT DE 3 LBS. DE PORC HACHE

## Grocery Specials

FROZO FROZEN  
2 LBS. PKG.

**FRENCH FRIED  
POTATOES** 59¢

POMMES DE TERRE-FRITES CONGEELES PQT. 2 LBS.  
FRASER VALE FROZEN FRESH 15 OZ.

**SLICED  
STRAWBERRIES** 49¢

FRAISES TRANCHEES

LYNN VALLEY ASSORTED SIZES

**GREEN PEAS** 45¢

2 BTES.  
14 OZ.  
CAN

POIS VERTS GROSSEURS ASSORTIES

LOWNEY'S VESTA

**CHOCOLATE BOX** 3.19

BOITE  
5 LBS.  
BOX

BOITE DE CHOCOLAT VESTA

OCEAN SPRAY 14 OZ.

**CRANBERRY SAUCE** 33¢

SAUCE AUX CANNEBERGES 14 OZ.

HABITANT

**PICKLED BEETS** 47¢

BETTERAVES MARINEES HABITANT

POT  
24 OZ.  
JAR

## Tempting Produce

FRESHNESS IS MORE THAN A WORD WITH US

**DELICIOUS APPLES  
POMMES** 99¢

EXTRA  
FANCY

RED DELICIOUS

EMPERORS U.S. NO 1

FANCY

**RED GRAPES** 69¢

RAISINS ROUGES EMPERORS

3  
LBS.

PARADISE MEADOW

**CRANBERRIES** 39¢

CANNEBERGES FRAICHES BTE. 1-LB BOX

WASCO

1-LB BAG

**MIXED NUTS** 73¢

IN SHELL

NOIX EN ECALÉ MELANGEES SAC 1-LB.

PRICES EFFECTIVE UNTIL CLOSING SAT. JAN. 3RD. 1970  
PRIX EN VIGUEUR JUSQU'À LA FERMETURE, SAM, 3RD. JAN. 1970.



YOUR  
ONE STOP  
SHOP

SHOP EARLY FOR  
BEST SELECTIONS

# BOWRINGS

SUPERMARKET - LABRADOR CITY

STORE WILL BE OPEN EVERY NIGHT TILL 9 O'CLOCK  
LE MAGASIN SERA OUVERT JUSQU'À 9 HEURES TOUS LES SOIRS